



KERN ALT

Version 1.0 12/2004

Operating Instructions Electronic analytical balance

Table of contents

1	Technical data	71
2	Declaration of conformity	72
3	Fundamental information (general)	74
3.1	Designated use	74
3.2	Inappropriate use	74
3.3	Guarantee	74
3.4	Monitoring the test substances	75
4	Fundamental safety instructions	75
4.1	Observe notices in the operating manual	75
4.2	Training of personnel	75
5	Transport and storage	75
5.1	Acceptance check	75
5.2	Packing	75
6	Unpacking, installation and commissioning	76
6.1	Installation Site, Location of Use	76
6.2	Unpack	76
6.2.1	Assembly	77
6.2.2	Scope of delivery	77
6.3	Mains supply	78
6.4	Connection of peripheral equipment	78
6.5	Initial Commissioning	78
7	User menu	79
7.1	User principle of the menu control	80
7.2	Operating the balance with PS/2 keyboard (see chapter 6.3)	81
7.3	Menu selection	82
7.3.1	P1 adjustment	82
7.3.2	P2 GLP (Good laboratory practice)	90
7.3.3	P3 Date/time	92
7.3.4	P4 Readout	94
7.3.5	P5 RS-232	96
7.3.6	P6 Printouts	96
7.3.7	P7 Weighing units	101
7.3.8	P8 operating modes	101
7.3.9	P9 General functions	102

8	Operation	103
8.1	Operating modes (P8 modes)	105
8.1.1	Simple weighing	107
8.1.2	Parts counting	109
8.1.3	Weighing with tolerance range	117
8.1.4	Filling	119
8.1.5	Percent determination	120
8.1.6	Animal weighing (Dynamic weighing)	122
8.1.7	Density determination	124
8.1.8	Formulation	125
8.1.9	Statistics	129
9	Data output	131
9.1	Tecnical data	131
9.2	Pin allocation of the balance exit plug (front view)	131
9.3	Remote commands	132
10	Maintenance, upkeep, disposal	133
10.1	Cleaning	133
10.2	Maintenance, upkeep	133
10.3	Disposal	133
11	Troubleshooting	134

1 Technical data

KERN	ALT 100-4M	ALT 160-5D	ALT 220-4M	ALT 310-4
Readout (d)	0.1 mg	0.1mg/0.01mg	0.1 mg	0.1 mg
Weighing range (Max)	100 g	160 g/60 g	220 g	310 g
Taring range (subtractive)	100 g	160 g/60 g	220 g	310 g
Reproductability	0.2 mg	0.2mg/0.1mg	0.2 mg	0.2 mg
Linearity	± 0.2 mg	± 0,2mg/0,1mg	± 0.2 mg	± 0.3 mg
Minimal piece weight for counting function	0,2 mg	0,2 mg	0,2 mg	0,2 mg
Adjustment weight	internal	internal	internal	internal
Verifiable	yes	no	yes	no
Verification value (e)	1 mg	-	1 mg	-
Accuracy category	I	-	I	-
Reference piece numbers for parts counting	10, 20, 50, 100, freely selectable			
Weighing Units	mg, g, ct,		mg, g, ct, lb, oz, ozt, dwt, t {h}, t {S}, t {t}, mom, GN, N, t, freely programmable	
Stabilization time (typically)	4 sec.			
Permissible ambient temperature	+ 15° C +30° C			
Humidity of air:	max. 80 % (not condensing)			
Under floor weighing device	On-hook eyelets, serial			
Weighing plate mm	100	80	100	
Housing (W x D x H) mm	205 x 500 x 290			
Weight kg (net)	8,9			

2 Declaration of conformity



KERN & Sohn GmbH

D-72322 Balingen-Frommern

Postfach 4052

E-Mail: info@kern-sohn.de

Tel: 0049-[0]7433- 9933-0

Fax: 0049-[0]7433-9933-149

Internet: www.kern-sohn.de

Konformitätserklärung

Declaration of conformity for apparatus with CE mark

Konformitätserklärung für Geräte mit CE-Zeichen

Déclaration de conformité pour appareils portant la marque CE

Declaración de conformidad para aparatos con marca CE

Dichiarazione di conformità per apparecchi contrassegnati con la marcatura CE

- English** We hereby declare that the product to which this declaration refers conforms with the following standards.
- Deutsch** Wir erklären hiermit, dass das Produkt, auf das sich diese Erklärung bezieht, mit den nachstehenden Normen übereinstimmt.
- Français** Nous déclarons avec cela responsabilité que le produit, auquel se rapporte la présente déclaration, est conforme aux normes citées ci-après.
- Español** Manifestamos en la presente que el producto al que se refiere esta declaración está de acuerdo con las normas siguientes
- Italiano** Dichiariamo con ciò che il prodotto al quale la presente dichiarazione si riferisce è conforme alle norme di seguito citate.

Electronic Balance: KERN ALT

Mark applied	EU Directive	Standards
	89/336EEC EMC	EN 61000-4-2 :1999 EN 61000-4-3 :1996 EN 61000-4-4 : 1999 EN 61000-4-5 : 1998 EN 61000-4-6 : 1999 EN 61000-4-11 : 1997 EN 55022 :2000

Date: 18.01.2005

Signature:

Gottl. KERN & Sohn GmbH
Management

Gottl. KERN & Sohn GmbH, Ziegelei 1, D-72336 Balingen, Tel. +49-[0]7433/9933-0, Fax +49-[0]7433/9933-149



KERN & Sohn GmbH

D-72322 Balingen-Frommern

Postfach 4052

E-Mail: info@kern-sohn.de

Tel: 0049-[0]7433- 9933-0

Fax: 0049-[0]7433-9933-149

Internet: www.kern-sohn.de

Konformitätserklärung

Declaration of conformity for apparatus with CE mark

Konformitätserklärung für Geräte mit CE-Zeichen

Déclaration de conformité pour appareils portant la marque CE

Declaración de conformidad para aparatos con marca CE

Dichiarazione di conformità per apparecchi contrassegnati con la marcatura CE

- English** We hereby declare that the product to which this declaration refers conforms with the following standards.
This declaration is only valid with the certificate of conformity by a notified body.
- Deutsch** Wir erklären hiermit, dass das Produkt, auf das sich diese Erklärung bezieht, mit den nachstehenden Normen übereinstimmt.
Diese Erklärung gilt nur in Verbindung mit der Konformitätsbescheinigung einer benannten Stelle.
- Français** Nous déclarons avec cela responsabilité que le produit, auquel se rapporte la présente déclaration, est conforme aux normes citées ci-après.
Cette déclaration est valide seulement avec un certificat de conformité d'un organisme notifié.
- Español** Manifestamos en la presente que el producto al que se refiere esta declaración está de acuerdo con las normas siguientes.
Esta declaración solo será válida acompañada del certificado de conformidad de conformidad de la parte nominal.
- Italiano** Dichiariamo con ciò che il prodotto al quale la presente dichiarazione si riferisce è conforme alle norme di seguito citate.
Questa dichiarazione sarà valida solo se accompagnata dal certificato di conformità della parte nominale.

Model:	KERN ALT 100-4M KERN ALT 220-4M
---------------	--

EU Directive	Standards	EC-type-approval certificate no.	Issued by
90/384/EEC	EN 45501	T6655	NMI

Date: 18.01.2005

Signature:

Gottl. KERN & Sohn GmbH
Management

Gottl. KERN & Sohn GmbH, Ziegelei 1, D-72336 Balingen, Tel. +49-07433/9933-0, Fax +49-074433/9933-149

3 Fundamental information (general)

3.1 Designated use

The balance you have acquired serves to determine the weighing value of the material to be weighed. It is intended to be used as a “non-automatic“ balance, i.e. the material to be weighed is manually and carefully placed in the centre of the weighing plate. The weighing value can be read off after a stable weighing value has been obtained.

3.2 Inappropriate use

Do not use balance for dynamic add-on weighings, if small amounts of goods to be weighed are removed or added. The “stability compensation“ installed in the balance may result in displaying an incorrect measuring value! (Example: Slowly draining fluids from a container on the balance.)

Do not leave a permanent load on the weighing plate. This can damage the measuring system.

Be sure to avoid impact shock and overloading the balance in excess of the prescribed maximum load rating (max.), minus any possible tare weight that is already present. This could cause damage to the balance.

Never operate the balance in hazardous locations. The series design is not explosion-proof.

Structural alterations may not be made to the balance. This can lead to incorrect weighing results, faults concerning safety regulations as well as to destruction of the balance.

The balance may only be used in compliance with the described guidelines. Varying areas of application/planned use must be approved by KERN in writing.

3.3 Guarantee

The guarantee is not valid in the following cases:

- non-observation of our guidelines in the operating instructions
- use outside the described applications
- alteration to or opening of the device
- mechanical damage and damage caused by media, liquids, natural wear and tear
- inappropriate erection or electric installation
- overloading of the measuring equipment

3.4 Monitoring the test substances

The metrology features of the balance and any possible available adjusting weight must be checked at regular intervals within the scope of quality assurance. For this purpose, the answerable user must define a suitable interval as well as the nature and scope of this check. Information is available on KERN's home page (www.kern-sohn.com) with regard to the monitoring of balance test substances and the test weights required for this. Test weights and balances can be adjusted quickly and at a reasonable price in KERN's accredited DKD calibration laboratory (return to national normal).

4 Fundamental safety instructions

4.1 Observe notices in the operating manual

Please read the operating instructions carefully before erecting and commissioning, even if you already have experience with KERN balances.

4.2 Training of personnel

The device may only be operated and looked after by trained members of staff.

5 Transport and storage

5.1 Acceptance check

Please check the packaging immediately upon delivery and the device during unpacking for any visible signs of external damage.

5.2 Packing

Please retain all parts of the original packaging in case it should be necessary to return items at any time.

Only the original packaging should be used for return consignments.

Before despatch, disconnect all attached cables and loose/movable parts.

Apply any intended transport security devices. Secure all parts e.g. weighing plate, mains power supply etc. against slipping and damage.

6 Unpacking, installation and commissioning

6.1 Installation Site, Location of Use

The balance is constructed in such a way that reliable weighing results can be achieved under normal application conditions.

By selecting the correct location for your balance, you will be able to work quickly and precisely.

Therefore please observe the following at the place of installation:

- Place the balance on a firm, level surface;
- Avoid extreme heat as well as temperature fluctuation caused by installing next to a radiator or in the direct sunlight;
- Protect the balance against direct draughts due to open windows and doors;
- Avoid jarring during weighing;
- Protect the balance against high humidity, vapours and dust;
- Do not expose the device to extreme dampness for longer periods of time. Inadmissible bedewing (condensation of air moisture on the device) can occur if a cold device is taken into a significantly warmer environment. In this case, please acclimatise the device for approx. 2 hours at room temperature after it has been disconnected from the mains.
- Avoid static charging of items to be weighed, or weighing container.

Major display deviations (incorrect weighing results) are possible if electromagnetic fields occur as well as due to static charging, currents and instable power supply. It is then necessary to change the location.

6.2 Unpack

Carefully remove the balance from its packaging, remove the plastic wrapping and position the balance in its intended working location.

6.2.1 Assembly

Structure of the balance:

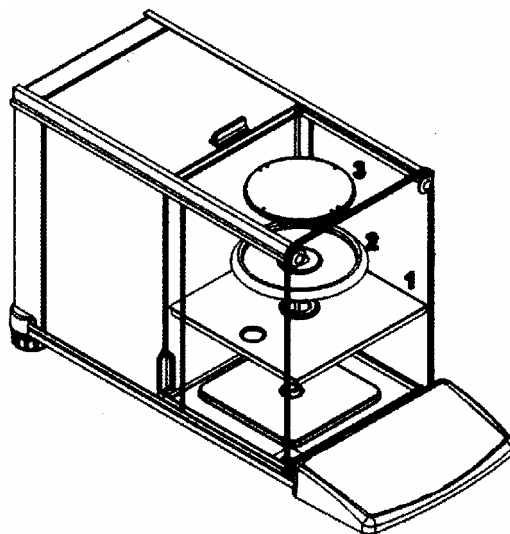

- (1) Base plate
- (2) Screen ring
- (3) Weighing plate

Use the foot screws to level the balance until the air bubble in the bubble level is in the prescribed circle.

6.2.2 Scope of delivery

Standard accessories:

- Scales
- Weighing plate
- Network appliance
- Instruction manual
- Wind protection

6.3 Mains supply

Electric power supply is by means of the external mains supply circuit. The printed voltage level must comply with the local voltage.

Only use original KERN mains supply circuits. The use of other makes is subject to approval by Kern.

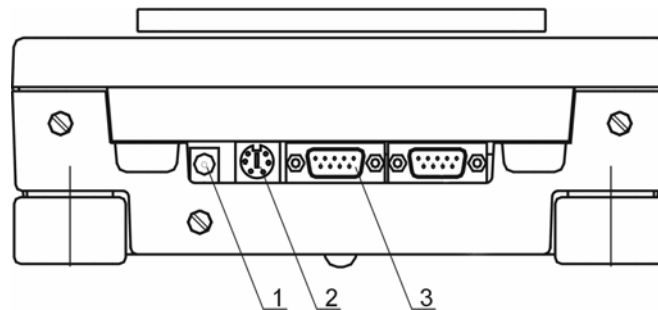

1. Mains supply
2. PS/2 keyboard
3. RS232 interface

6.4 Connection of peripheral equipment

The balance must be disconnected from the mains before connecting or disconnecting additional equipment (printer, PC) to or from the data interface.

Only use KERN accessories and peripheral equipment with your balance. These have been ideally coordinated to your balance.

6.5 Initial Commissioning

A warm-up time of 1 hour stabilises the measured values after switching on.

The accuracy of the balance depends on the local acceleration of the fall.

Instructions in chapter Adjustment must be observed.

7 User menu

The user menu has nine main menus with the following sub-menus:

P1 Calibration	P2 GLP	P3 Date/Time	P4 Readout	P5 RS-232	P6 Printouts	P7 Units	P8 Modes	P9 Globals
Int. calibr. Ext. calibr. User calibr. Calibr. Test: Weight.corr. Aut. calibr. Print report	User No. Prj. No. Time print Date print UserNo. print Prj. No. print Id print Diff. print	Date format Time format Time Date Disp. time Disp. date	Filter Filter range Disp refresh Stable range Stable speed Autozero Last digit	Boud rate Parity Data bits Stop bits Handshake Auto print Interval Print on stab	Printout No. Pr. 1 start Pr. 1 stop Pr. 2 start Pr. 2 stop Pr. 3 start Pr. 3 stop Pr. 4 start Pr. 4 stop String 1 String 2 String 3 . . String 78 String 79 String 80	Grams Miligrams Kilograms Pounds Ounces, Ounces troy Carats Dwt Tael. Hk Tael. S Tael. T Mommies Granis Newtons Tical Custom Custom Factor	Parts Count Checkweighing Filling Percont Animal Formulation Statistics Density	Beep Language Backlight Contrast Screensaver Temperature Balance Id Software rev. Par. Printout Par. Receive. Factory def.

Main Menu

	<ol style="list-style-type: none"> 1. Menu number (P1 – P9) 2. Menu designation 3. Cursor (▶) indicates the current menu item
--	--

Submenu:

	<ol style="list-style-type: none"> 1. Menu number (P1 – P9) 2. Parameter number and designation 3. Parameter value or ***** i.e. this parameter is available as a function 4. Functional Description 5. Cursor (▶) indicates the current menu item (e.g. P1). 6. Cursor (▶) indicates the current parameter (e.g. 06). 7. "Setup" i.e. the user is in Setup Mode. 8. Use the arrow key to modify the parameter value, the active parameter blinks.
--	--

7.1 User principle of the menu control

In the menu the settings of the balance can be modified and functions can be activated.



This way, the balance can be adjusted to individual weighing requirements. To do so proceed as follows:

⇒ Use the -key to turn on the balance.

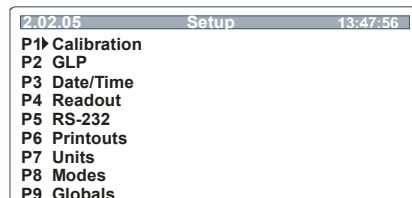
⇒ After actuating the -key the display shows the main menus that can be set



⇒ Select your setting using the cursor (▶).



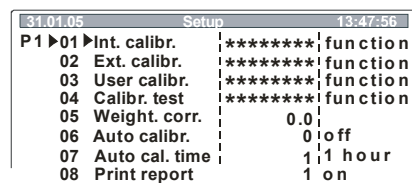

Use the -key to move the cursor (▶) down, the -key to move it up

⇒ The -key confirms your selected setting, the display shows the sub-menu or the active menu item blinks:

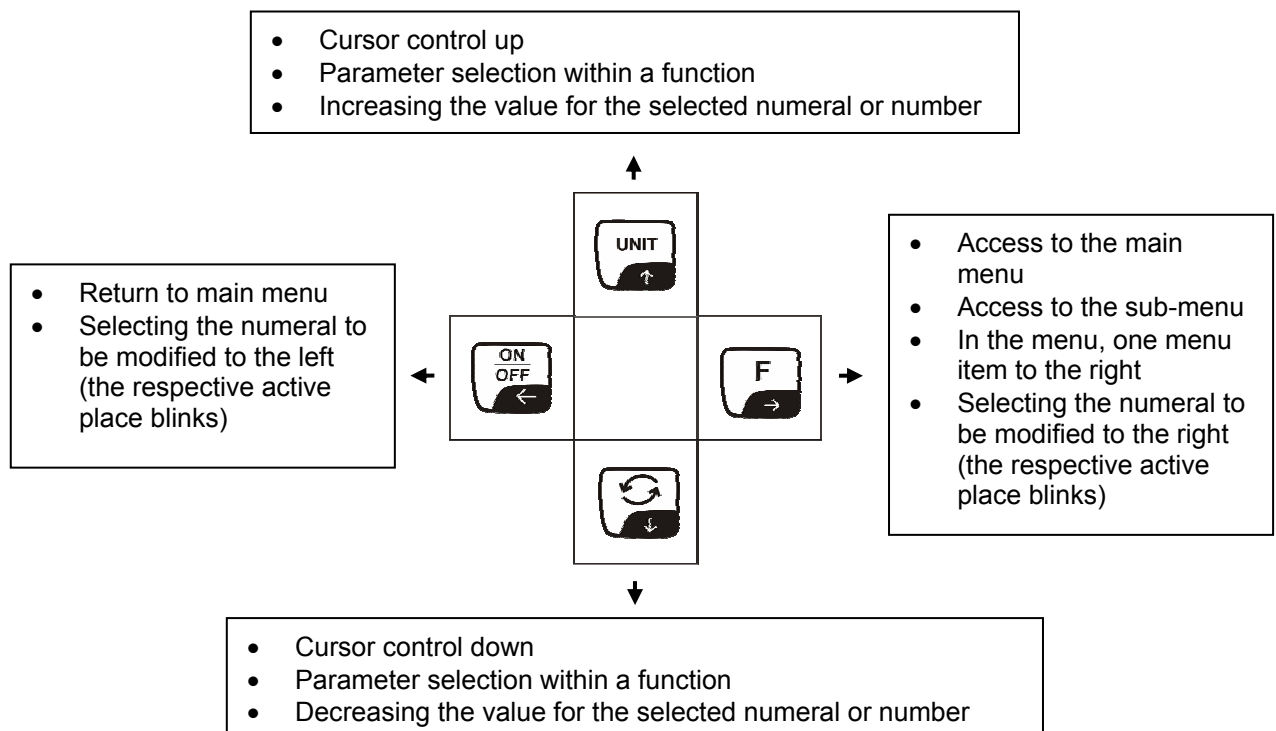



⇒ Use the arrow keys to move within and enter into the menu:

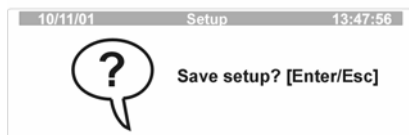

- ⇒ Use the -key to confirm or the -key to cancel
- ⇒ Use the -key to return to the menu
- ⇒ Actuate -key again, a message will inquire whether you want to save the changes you made.



- ⇒ Actuating the -key will save the selected setting.
- ⇒ If you do not want to save the selected setting press 





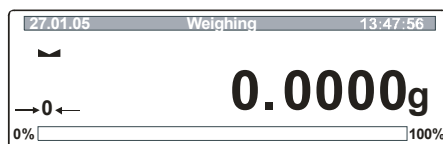





















- ⇒ The balance will automatically return to weighing mode



7.2 Operating the balance with PS/2 keyboard (see chapter 6.3)

Using a PS/2 keyboard will help you to enter numbers and texts faster and easier.

Key allocation:

						Balance keyboard
						PS keyboard
						
						
						
						

7.3 Menu selection

7.3.1 P1 Calibration (Adjustment)

As the acceleration value due to gravity is not the same at every location on earth, each balance must be coordinated - in compliance with the underlying physical weighing principle - to the existing acceleration due to gravity at its place of location (only if the balance has not already been adjusted to the location in the factory). This adjustment process must be carried out for the first commissioning, after each change of location as well as in case of fluctuating environment temperature. It is also recommendable to adjust the balance periodically during weighing operation in order to obtain exact measured values.

Using the inbuilt adjusting weight the balance automatically carries out an adjustment after any temperature change of 0.8 °C or any time it was disconnected from the power supply.

Of course it is also possible to check the accuracy of the balance manually any time. You can choose between two options:



1. Adjustment is started by pressing the -key three times.
After successful adjustment the balance automatically returns to weighing mode.
2. Under menu item **“P1 01 Calibration with internal weight”** (see table below)

Procedure for adjustment:

Observe stable environment conditions. A warming-up time of ca. 1 hour for stabilisation is necessary.

Important!

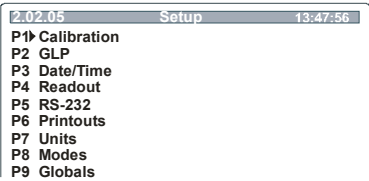
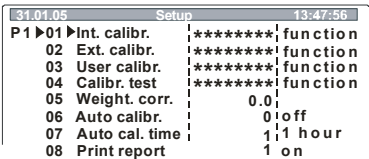
During the adjustment process no objects should be on the weighing plate.

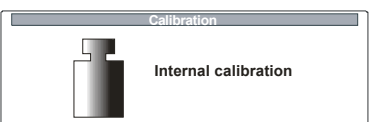
Operator	Indication
<p>⇒ Call up menu item “P1 Calibration “ (see chapter 7.1)</p> <p>⇒ Press -key</p>	
01 Int. calibr. - Adjustment with internal weight	
<p>⇒ Use the cursor (▶) to select “01 Int. calibr. “</p>	
<p>⇒ Press the -key; the adjustment with internal weight is carried out.</p>	

⇒ After successful adjustment the balance automatically returns to weighing mode. In case of an adjustment error (e.g. objects on the weighing plate) the display will show an error message, repeat adjustment.

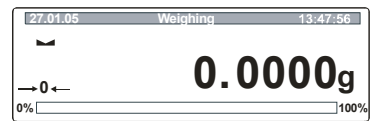

02 Ext. Cal - Adjustment with an external weight

Locked for verifiable appliances

03 User cal. – locked for verifiable appliances

04 Cal. test – not documented

05 Weight corr. – locked for verifiable appliances

06 Autom. cal. – locked for verifiable appliances

07 Auto. Cal.time – locked for verifiable appliances

08 Print report – printout of the adjustment data

⇒ Use the cursor (▶) to select “**08 “print report”**”

⇒ Press the -key; the current menu item blinks. Use the arrow keys (see chapter 7.1) to save your settings

- 0** **Print report** deactivated
- 1** **Print report** activated

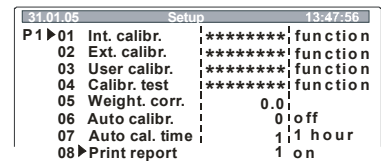





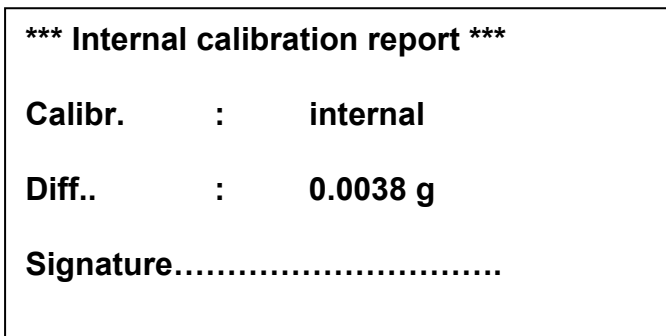

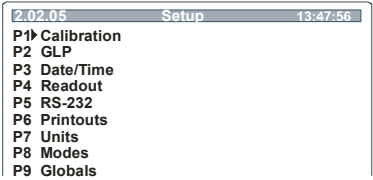
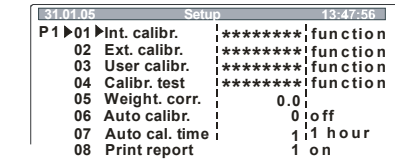

⇒ Confirm with -key

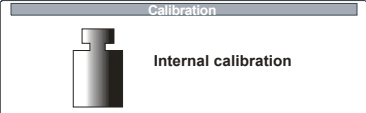
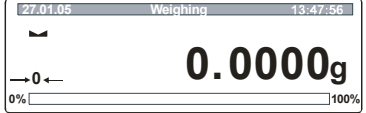
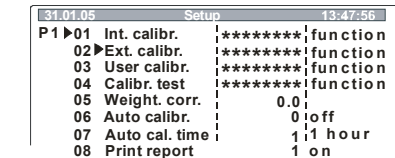
⇒ When **print report** is activated you will receive a printout of your adjustment data after each adjustment (Ex.):

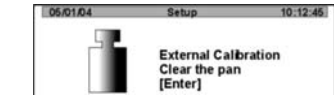

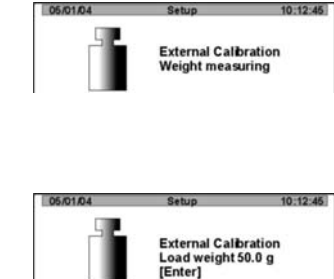
7.3.1.1 Calibration (adjustment) only for model KERN ALT 310

Operator	indication
<p>⇒ Call up menu item “P1 Calibration“ (see chapter 7.1)</p> <p>⇒ Press -key</p>	 <pre> 2.02.05 Setup 13:47:56 P1▶ Calibration P2 GLP P3 Date/Time P4 Readout P5 RS-232 P6 Printouts P7 Units P8 Modes P9 Globals </pre>
<h4>01 Int. cal. - Adjustment with internal weight</h4>	
<p>⇒ Use the cursor (▶) to select “01 Int. cal.“</p>	 <pre> 31.01.05 Setup 13:47:56 P1▶01▶ Int. calibr. ***** function 02 Ext. calibr. ***** function 03 User calibr. ***** function 04 Calibr. test ***** function 05 Weight. corr. 0.0 06 Auto calibr. 0 off 07 Auto cal. time 1 hour 08 Print report 1 on </pre>
<p>⇒ Press the  key; the adjustment with internal weight is carried out.</p>	
<p>⇒ After successful adjustment the balance automatically returns to weighing mode. In case of an adjustment error (e.g. objects on the weighing plate) the display will show an error message, repeat adjustment.</p>	
<h4>02 Ext. Cal - Adjustment with an external weight</h4>	
<p>⇒ Use the cursor (▶) to select “02 Ext. cal.“</p>	 <pre> 31.01.05 Setup 13:47:56 P1▶01 Int. calibr. ***** function 02▶ Ext. calibr. ***** function 03 User calibr. ***** function 04 Calibr. test ***** function 05 Weight. corr. 0.0 06 Auto calibr. 0 off 07 Auto cal. time 1 hour 08 Print report 1 on </pre>
<p>⇒ Press -key Ensure that there are no objects on the weighing plate.</p>	
<p>⇒ Press -key; the display shows the measuring value of the adjusting weight.</p>	

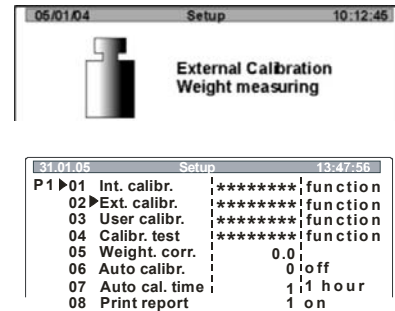

⇒ Now place the adjusting weight in the center of the weighing plate, press the -key. After successful adjustment the system will automatically return to the menu. The -key can be used to cancel the adjustment. In case of an adjustment error or incorrect adjusting weight an error message is displayed. Repeat adjustment.



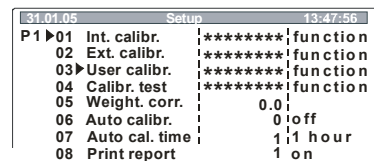

03 User calibr. – user-defined adjusting weight

⇒ Use the cursor (▶) to select “03 User. cal.”

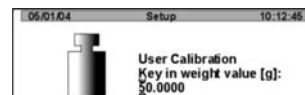

⇒ Press -key; the display shows the measuring value of the adjusting weight. The first numeral of the displayed value blinks. You can modify it using the arrow keys. After setting your new adjusting weight use the -key to confirm.



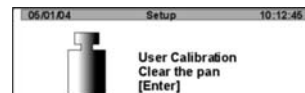

⇒ Ensure that there are no objects on the weighing plate. Press -key

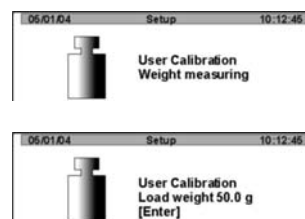

⇒ Press the  key; the display shows the measuring value you selected for the adjusting weight



⇒ Now place the adjusting weight in the center of the weighing plate, press the -key. After successful adjustment the system will automatically return to the menu.
 The -key can be used to cancel the adjustment.
 In case of an adjustment error or incorrect adjusting weight an error message is displayed. Repeat adjustment.

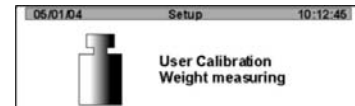

```

31.01.05 Setup 13:47:56
P1 ▶01 Int. calibr. |*****|function
02 Ext. calibr. |*****|function
03▶User calibr. |*****|function
04 Calibr. test |*****|function
05 Weight. corr. | 0.0 |
06 Auto calibr. | 0 |off
07 Auto cal. time | 1 |hour
08 Print report | 1 |on
  
```

We recommend:

Carry out adjustment as close to the maximum load of the balance as possible. Information concerning the test weights is available at: <http://www.kern-sohn.com>

04 Calibration test

Here, deviation from the last adjustment is determined. This is only a check, i.e. no values are changed.

⇒ Use the cursor (▶) to select “04 Cal. test“

```

31.01.05 Setup 13:47:56
P1 ▶01 Int. calibr. |*****|function
02 Ext. calibr. |*****|function
03 User calibr. |*****|function
04▶Calibr. test |*****|function
05 Weight. corr. | 0.0 |
06 Auto calibr. | 0 |off
07 Auto cal. time | 1 |hour
08 Print report | 1 |on
  
```

⇒ Press the -key, the calibration test is started

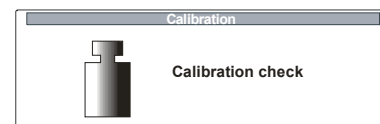

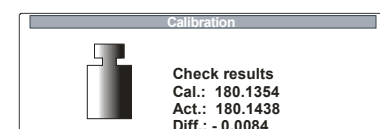

⇒ The result is displayed



05 Weight corr. – not documented

06 Automatic calibration

- ⇒ Use the cursor (▶) to select “**06 Autom. cal.**”
- ⇒ Press the -key; the current menu item blinks.
- ⇒ Use the  - or  - key to choose between the following settings:

- 0 no Autom. calibration locked**
- 1 Temp.Autom. Calibration for a
Temperature change of 0.8 °C**
- 2 Time Autom. Calibration after
a user-defined interval**
- 3 both Autom. Calibration for a
Temperature change of
0.8 °C or after the
defined interval**

```

31.01.05      Setup      13:47:56
P1 ▶01 Int. calibr.      |*****|function
02 Ext. calibr.      |*****|function
03 User calibr.      |*****|function
04 Calibr. test      |*****|function
05 Weight. corr.      |      |0.0|
06 ▶Auto calibr.      |      |0|off
07 Auto cal. time |      |1|1 hour
08 Print report      |      |1 on
    
```

- ⇒ Confirm with -key

07 Auto cal. time - Automatic calibration after a user-defined interval

- ⇒ Use the cursor (▶) to select “**07 Auto.cal.time**”
- ⇒ Press the -key; the current menu item blinks.
- ⇒ Use the arrow keys to enter a value between 1 and 12 hours.

```

31.01.05      Setup      13:47:56
P1 ▶01 Int. calibr.      |*****|function
02 Ext. calibr.      |*****|function
03 User calibr.      |*****|function
04 Calibr. test      |*****|function
05 Weight. corr.      |      |0.0|
06 Auto calibr.      |      |0|off
07 ▶Auto cal. time |      |1|1 hour
08 Print report      |      |1 on
    
```

- ⇒ Confirm with -key

08 Print report

In this menu item you can activate the function for printing your calibrating data

⇒ Use the cursor (▶) to select “08 “print report“

⇒ Press the  key; the current menu item blinks.
Use the arrow keys (see chapter 7.1) to save your settings

0 Print report deactivated

1 Print report activated

```

31.01.05      Setup      13:47:56
P1▶01 Int. calibr.  |*****|function
02 Ext. calibr.   |*****|function
03 User calibr.  |*****|function
04 Calibr. test  |*****|function
05 Weight. corr. |      |0.0|
06 Auto calibr.  |      |0|off
07 Auto cal. time|      |1|1 hour
08▶Print report  |      |1|on
    
```

⇒ Confirm with  -key

⇒ When **print report** is activated you will receive a printout of your adjustment data after each adjustment (Ex.):

***** Internal calibration report*****

Calibr. : internal

diff.. : 0,0038 g

Name.....

***** External calibration report *****

Calibr. : external

diff.. : -0,0624 g

Name

***** User calibration report*****

Calibr. : User calibration

diff.. : -0,0003 g

Name

7.3.1.2 Verification

General:

According to the EU guideline 90/384/EEC balances must be verified officially if they are to be used as follows (legally regulated area):

- a) For commercial transactions if the price of goods is determined by weighing
- b) For the production of medicines in pharmacies as well as for analyses in the medical and pharmaceutical laboratory
- c) For official purposes
- d) For the production of finished packages

In case of doubt, please contact your local office of weights and measures.

Verification information

An EU qualification approval is available for those balances marked as appropriate for verification in the technical data. In the event that the balance is applied in an area subject to verification as described above, it must be officially verified and re-verified at regular intervals.

Re-verification of a balance is carried out in compliance with the respective legal provisions of the states. The term of verification validity for balances in Germany, for example, is normally 2 years.

The legal provisions of the country of use are to be observed.

After verification the balance is sealed at the marked positions.

Verification of the balance is invalid without the seal.

Position of the seal:

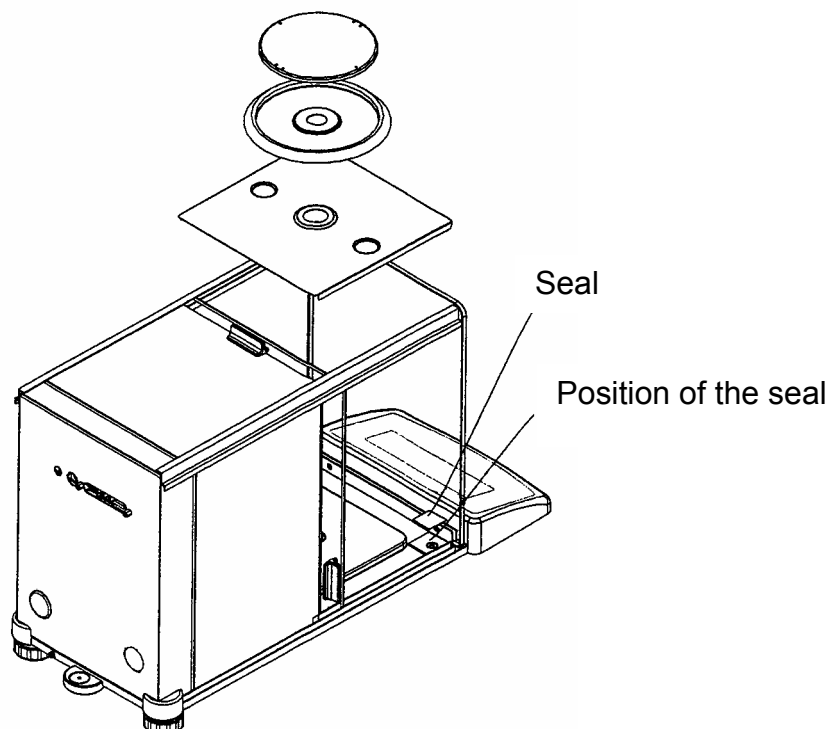







Balances with obligatory verification must be taken out of service if:

- **The weighing result of the balance is outside the maximum limits of operating errors.** Therefore load balance is regular intervals with known test weight (ca. 1/3 of the max. load) and compare with displayed value.
- **The date for subsequent or periodical verification has passed.**

7.3.2 P2 GLP (Good laboratory practice)

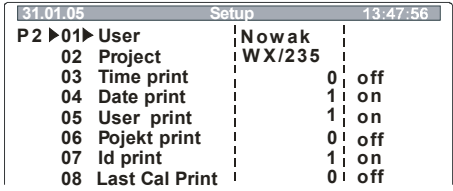
Quality assurance systems require printouts of weighing results as well as of correct adjustment of the balance stating date and time and balance identification. The easiest way is to have a printer connected.

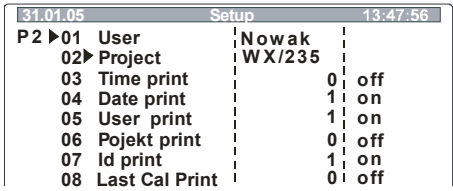
Definition of a standard log:

Operator	Indication
<p>⇒ Call up menu item “P2 GLP” (see chapter 7.1)</p> <p>⇒ Press -key</p>	 <pre> 20.02.05 Setup 13:47:56 P1 Calibration P2 GLP P3 Date/Time P4 Readout P5 RS-232 P6 Printouts P7 Units P8 Modes P9 Globals </pre>
01 User	
<p>⇒ Use the cursor (▶) to select “01 User”</p> <p>⇒ Press the -key; the current menu item blinks. Use the arrow keys (see chapter 7) to enter user name or number (max. 8 characters).</p>	 <pre> 31.01.05 Setup 13:47:56 P2 ▶01 User Nowak 02 Project WX/235 03 Time print 0 off 04 Date print 1 on 05 User print 1 on 06 Pojekt print 0 off 07 Id print 1 on 08 Last Cal Print 0 off </pre>
<p>⇒ Confirm with -key</p>	
02 Project	
<p>⇒ Use the cursor (▶) to select “02 Project”</p> <p>⇒ Press the -key; the current menu item blinks. Use the arrow keys (see chapter 7) to enter project name or number (max. 8 characters)</p>	 <pre> 31.01.05 Setup 13:47:56 P2 ▶01 User Nowak 02▶ Project WX/235 03 Time print 0 off 04 Date print 1 on 05 User print 1 on 06 Pojekt print 0 off 07 Id print 1 on 08 Last Cal Print 0 off </pre>
<p>⇒ Confirm with -key</p>	
<p>All other settings (03 – 08) are carried out in the same way.</p>	

All settings that should be printed must be activated with "on".

Example 1:

Settings

P2	03	Printout time	1	yes
P2	04	Printout date	1	yes
P2	05	User printout	1	yes
P2	06	Project printout	1	yes
P2	07	ID printout	1	yes
P2	08	Last cal. print	1	yes

Print

Date	: 18.01.05
Time	: 10:41:05
User	: Miller
Project:	: AB/007
Balance no.	: WL 041078

18.01.05	07:48
Automatic calibration	
Deviation.:	0.003[5] g

10.429[0] g	

Example 2:

Settings

P2	03	Printout time	0	no
P2	04	Printout date	1	yes
P2	05	User printout	1	yes
P2	06	Project printout	0	no
P2	07	ID printout	1	yes
P2	08	Last cal. print	0	no









Print

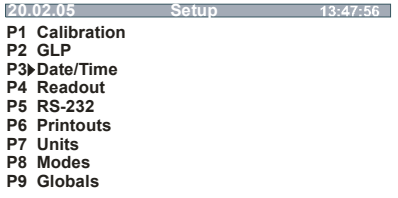

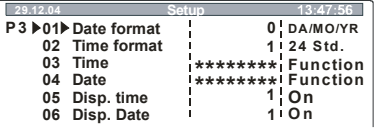



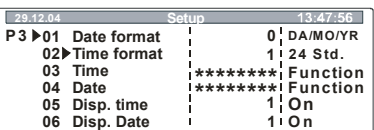



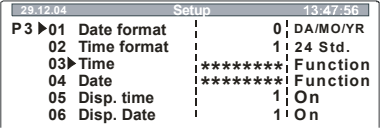

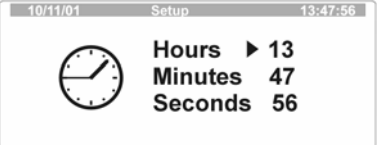

Date:	22/10/2004
User:	Miller
Balance no.:	10

13.0521 g	

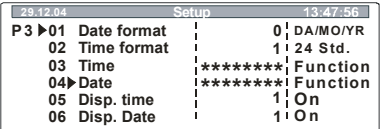

7.3.3 P3 Date/time

In this menu item you can call up output and formatting of set date and time.

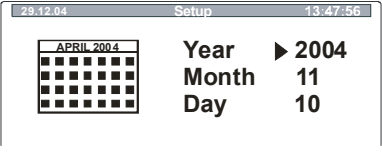
Operator	indication
<p>⇒ Menu item “P3 Date/time“ (see chapter 7.1)</p> <p>⇒ Press -key</p>	 <pre> 20.02.05 Setup 13:47:56 P1 Calibration P2 GLP P3▶Date/Time P4 Readout P5 RS-232 P6 Printouts P7 Units P8 Modes P9 Globals </pre>
<h4>01 Date format</h4>	
<p>⇒ Use the cursor (▶) to select “01 Date format“</p> <p>⇒ Press the -key; the current menu item blinks.</p> <p>⇒ Use the -key to choose between the following settings:</p> <p style="margin-left: 40px;">1 Month/Day/Year</p> <p style="margin-left: 40px;">0 Day/Month/Year</p>	 <pre> 29.12.04 Setup 13:47:56 P3 ▶01▶Date format 0 DA/MO/YR 02 Time format 1 24 Std. 03 Time ***** Function 04 Date ***** Function 05 Disp. time 1 On 06 Disp. Date 1 On </pre>
<p>⇒ Confirm with -key</p>	
<h4>02 Time format</h4>	
<p>⇒ Use the cursor (▶) to select “02 Time format“</p> <p>⇒ Press the -key; the current menu item blinks.</p> <p>⇒ Use the -key to choose between the following settings:</p> <p style="margin-left: 40px;">0 24 hours</p> <p style="margin-left: 40px;">1 12 hours (PM/AM)</p>	 <pre> 29.12.04 Setup 13:47:56 P3 ▶01 Date format 0 DA/MO/YR 02▶Time format 1 24 Std. 03 Time ***** Function 04 Date ***** Function 05 Disp. time 1 On 06 Disp. Date 1 On </pre>
<p>⇒ Confirm with -key</p>	

03 Time	
⇒ Use the cursor (▶) to select “03 Time“	
⇒ Press  -key	
⇒ Get to your selection with  - or  - key	
⇒ Use the  -key to confirm your selection (e.g. hours), the current menu item blinks.	
⇒ Use the  -key to increase the value, the  -key to decrease.	
⇒ Use the  - and  -keys to select the place to be changed (the respective active place blinks).	
⇒ Use the  -key to confirm your selection (e.g. hours).	
⇒ To change minutes and seconds proceed in the same way.	
⇒ Confirm with  -key	
04 Date	
⇒ Use the cursor (▶) to select “04 Date“	
⇒ Press  -key	
⇒ All other settings are the same as for entering time (03 Time).	

02 Disp. refresh



- ⇒ Use the cursor (▶) to select “02 Disp. refresh”
- ⇒ Press the  -key; the current menu item blinks.
- ⇒ With the  - and  - key you can select between the following adjustments:

1	0.1 s
↓	↓
5	0.5 s

29.12.04	Setup	13:47:56
P4▶ 01 Filter		5 Slowest.
02▶ Disp refresh		1 0.08 s
03 Autozero		1 On
04 Last digit		1 Always

- ⇒ Confirm with  -key



03 Autozero

- ⇒ Use the cursor (▶) to select “03 Autozero”
- ⇒ Press the  -key; the current menu item blinks.
- ⇒ With the  - and  -key you can select between the following adjustments:
 - 0** Deviations from the Zero display are **not** automatically tared.
 - 1** Deviations from the Zero display are automatically tared.

29.12.04	Setup	13:47:56
P4▶ 01 Filter		5 Slowest.
02 Disp refresh		1 0.08 s
03▶ Autozero		1 On
04 Last digit		1 Always

- ⇒ Confirm with  -key

04 Last digit





- ⇒ Use the cursor (▶) to select “04 Last digit”
- ⇒ Press the  -key; the current menu item blinks.
- ⇒ With the  - and  - key you can select between the following adjustments:
 - 0** 4 fractional digits.
 - 1** All fractional digits

29.12.04	Setup	13:47:56
P4▶ 01 Filter		5 Slowest.
02 Disp refresh		1 0.08 s
03 Autozero		1 On
04▶ Last digit		1 Always

- ⇒ Save with  -key

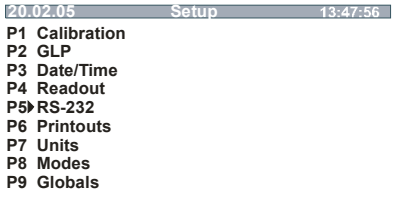

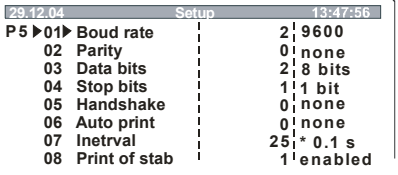



7.3.5 P5 RS-232

In this menu item you can save your settings for the interface.

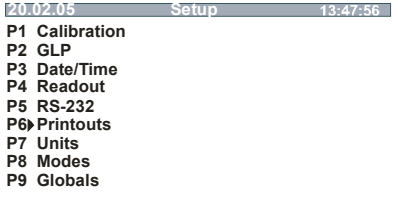
Operator	indication
<p>⇒ Call up menu item “P5 RS-232“ (see chapter 7.1)</p> <p>⇒ Press  -key</p>	
<p>01 – 10 Parameter selection</p>	
<p>⇒ Use the cursor (▶) to select your setting (01 – 10)</p> <p>⇒ Press the  -key; the current menu item blinks. Use the arrow keys (see chapter 7.1) to save your settings</p>	
<p>⇒ Confirm with  -key</p>	

7.3.6 P6 Printouts

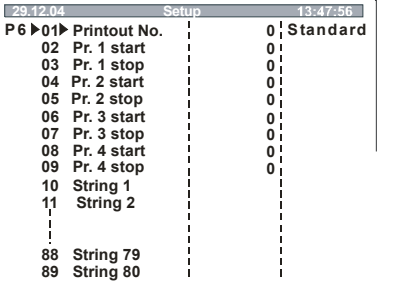
In this menu item you can select between 5 different types of data output:

Operator	indication
<p>⇒ Call up menu item “P6 Printouts“ (see chapter 7.1)</p> <p>⇒ Press  -key</p>	
<p>01 Printout No.</p>	
<p>⇒ Use the cursor (▶) to select your setting “01 Printout No.”</p> <p>⇒ Press the  -key; the current menu item blinks.</p> <p>⇒ With the  - and  - key you can select between the following adjustments:</p> <p>0 standard</p> <p>1 printout 1</p> <p>↓ ↓</p> <p>4 printout 4</p>	
<p>⇒ Use the  -key to confirm your selection</p>	

7.3.6.1 Standard-data output (0 standard)

Data output is carried out by actuating the -key.

Definition of the log header is executed in menu item “P2 GLP”.

Example

Date:	22/10/2004
Time	13.04.23
User:	Mustermann
Project:	XW/456
	0.008 g

Date:	22/10/2004
Time	13.16.49
User:	Mustermann
Project:	XW/456
Balance:	10
?	62.685 g *

*: ? = instable measuring value

7.3.6.2 User-defined data output (1 printout 1 ↔ 4 printout 4)

Here you can define 4 different kinds of data output (printout 1 – 4).

⇒ The content of the data output is defined as follows.

First line **printout 1 start -1**, i.e. text begins at line 1 (string 1)

Last line **printout 1 stop - 20**, i.e. text ends at line 20 (string 20)

⇒ Text input per line is carried out via the arrow keys (see chapter 7.1) in the respective strings.

string 1 Start of text input
string 20 End of text input

During text input lines may overlap, e.g.:

printout 1 start – 1
printout 1 stop – 40
printout 2 start – 20
printout 2 stop – 40

Text input:

- Max. 640 characters
- 80 lines
- 8 characters per line

⇒ After each line confirm your text input using the -key.

⇒ After complete text input press the -key; this is followed by an inquiry whether you want to save your setting.

⇒ Use the -key to confirm (see chapter 7.1).

Apart from flow text (characters, numbers and numerals) the following variables are stored in the menu:

General variables	
%%	Printout of 1 character “%”(i.e. in order to print out 1 character % two %% have to be entered)
%N	Net weight
%d	Current date
%t	Current time
%i	Balance ID-no.
%R	Program no.
%P	Project no.
%U	User no.
%F	Current function (operating mode)
%C	Date and time of last adjustment
%K	Type of last adjustment
%I	Deviation from last adjustment

Print related variables	
 	Printout of 1 character “ / ”(i.e. in order to print out 1 character / two // have to be entered)
lc	CRLF (carriage return line feed) Beginning of line next line
lr	CR (carriage return) beginning of line
ln	LF (line feed) next line
lt	Tabulator
ls	Next “string”
l0	End of data input

Variables in the various operating modes		
Variable	Description	Mode of operation
%W	Reference quantity	Parts counting
%V	Measuring value in number parts or in % (percent determination)	
%H	Lower limit	Weighing with tolerance range
%L	Upper limit	
%Z	Rated value	Dosing
%B	Reference mass	Percent determination
%A	Sensibility	Dynamic weighing (Animal weighing)
%b	Median Value	
%I	Method	Density determination
%p	Liquid	
%c	Temperature	
%a	Density liquid	
%v	Sinker	

Variable for statistics	
%n	Number weighings
%x	Median Value
%S	Sum of all measuring values
%m	Min value
%M	Max value
%D	Difference min and max value
%s	Standard Deviation
%r	Variance

Variables are entered either directly via arrow keys or more comfortably in menu item **P6 "10 Pr. Edit"**.

Examples for text input:

Example 1: *Max mass can not exceed 11.250 g!*

Parameter No.	Text							
	1	2	3	4	5	6	7	8
20 string 10	M	a	x		m	a	s	s
21 string 11		c	a	n		n	o	t
22 string 12		e	x	c	e	e	d	
23 string 13	1	1	.	2	5	0		g
24 string 14		!						
25 string 15								

Example 2: *Kern & Sohn GmbH*

Datum:

Zeit:

Gewicht:

******Unterschrift:.....*





**** Wägen mit Toleranzbereich****

Parameter Nr.	Text							
	1	2	3	4	5	6	7	8
26 string 16	K	e	r	n		&		S
27 string 17	o	h	n		G	m	b	H
28 string 18	\	c	D	a	t	u	m	:
29 string 19	%	d	\	c	Z	e	i	t
30 string 20	:	%	t	\	r	\	n	G
31 string 21	e	w	i	c	h	t	:	%
32 string 22	N	\	c	\	c	*	*	*
33 string 23	*	*	U	n	t	e	r	s
34 string 24	c	h	r	i	f	t	:	.
35 string 25
36 string 26	.	.	\	c	*	*	%	F
37 string 27	*	*	*	*				

7.3.7 P7 Weighing units

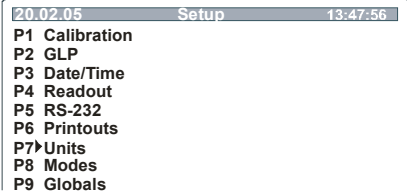
In this menu item you can activate various different weighing units (see chapter 1 “Technical data”).

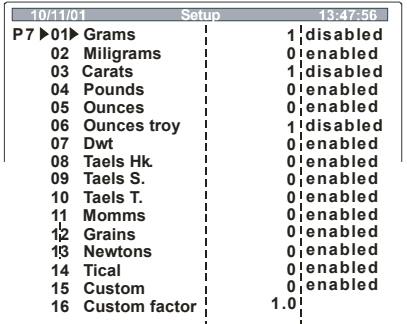





Switch into activated units by pressing the  - key several times.

Operator	indication
<p>⇒ Call up menu item “P7 Units“ (see chapter 7.1)</p> <p>⇒ Press  -key</p>	 <pre> 20.02.05 Setup 13:47:56 P1 Calibration P2 GLP P3 Date/Time P4 Readout P5 RS-232 P6 Printouts P7▶Units P8 Modes P9 Globals </pre>
<p>01 – 16 Parameter selection</p>	
<p>⇒ Use the cursor (▶) to select your setting (01 – 16)</p> <p>⇒ Press the  -key; the current menu item blinks. Use the arrow keys (see chapter 7.1) to save your settings</p> <p>0 Weighing unit deactivated 1 Weighing unit activated</p>	 <pre> 10/11/01 Setup 13:47:56 P7 ▶01▶ Grams 1 disabled 02 Milligrams 0 enabled 03 Carats 1 disabled 04 Pounds 0 enabled 05 Ounces 0 enabled 06 Ounces troy 1 disabled 07 Dwt 0 enabled 08 Taels Hk 0 enabled 09 Taels S. 0 enabled 10 Taels T. 0 enabled 11 Momms 0 enabled 12 Grains 0 enabled 13 Newtons 0 enabled 14 Tical 0 enabled 15 Custom 0 enabled 16 Custom factor 1.0 </pre>
<p>⇒ Use the  -key to confirm your selection</p> <p>⇒ Save (see chapter 7.1)</p>	

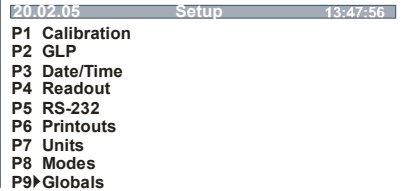
7.3.8 P8 operating modes

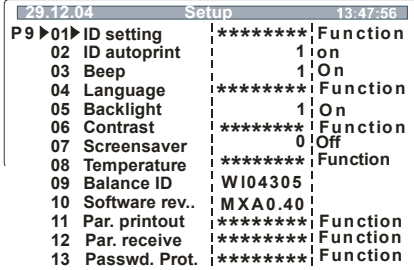
See chapter 8.1

7.3.9 P9 General functions

Operator	indication
<p>⇒ Call up menu item “P9 Globals“ (see chapter 7.1)</p> <p>⇒ Press  -key</p>	 <pre> 20.02.05 Setup 13:47:56 P1 Calibration P2 GLP P3 Date/Time P4 Readout P5 RS-232 P6 Printouts P7 Units P8 Modes P9▶Globals </pre>
01 – 13 Parameter selection	
<p>⇒ Use the  - and  -key to select parameter “01 - 13“</p>	 <pre> 29.12.04 Setup 13:47:56 P9 ▶01▶ID setting ***** Function 02 ID autoprint 1 on 03 Beep 1 On 04 Language ***** Function 05 Backlight 1 On 06 Contrast ***** Function 07 Screensaver 0 Off 08 Temperature ***** Function 09 Balance ID W104305 10 Software rev.. MXA0.40 11 Par. printout ***** Function 12 Par. receive ***** Function 13 Passwd. Prot. ***** Function </pre>
<p>01 ID setting</p> <p>02 ID Autoprint</p> <p>03 Beep</p> <p>04 Language</p> <p>05 Backlight</p> <p>06 Contrast</p> <p>07 Screensaver</p> <p>08 Temperature</p> <p>09 Balance ID</p> <p>10 Software rev</p> <p>11 Par. Printout</p> <p>12 Par receive</p> <p>13 Password protection</p>	<p>Entering a user code</p> <p>User code can also be printed</p> <p>Tone on/off</p> <p>User guidance selectable in German, English and Spanish</p> <p>Back lighting of the display on/off</p> <p>Contrast of the display</p> <p>Back lighting automatically switches off as soon as a stable measuring value is reached (Condition: Backlight on)</p> <p>Temperature display</p> <p>Balance identification no.</p> <p>Software issue</p> <p>Balance parameters are printed out</p> <p>not proved by documents</p> <p>Password protection</p>
<p>⇒ Press the  -key; the current menu item blinks.</p> <p>⇒ Activate / deactivate parameter with  - and  -key</p> <p>⇒ Confirm your selection with  -key</p>	

8 Operation

Operating elements

- Display:

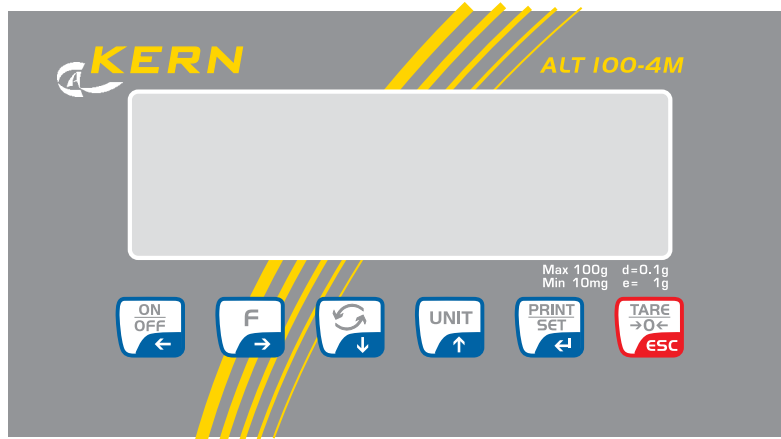

- Overview of display:

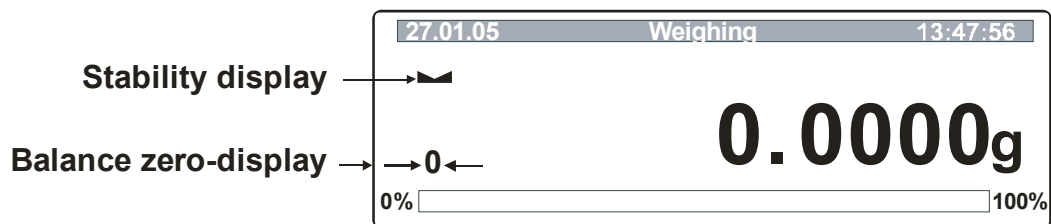

Balance zero-display:

If the balance does not show exactly zero although the pan scale is unloaded, press the -key and the balance will be reset to zero.

(Display [→0←]).

Stability display:





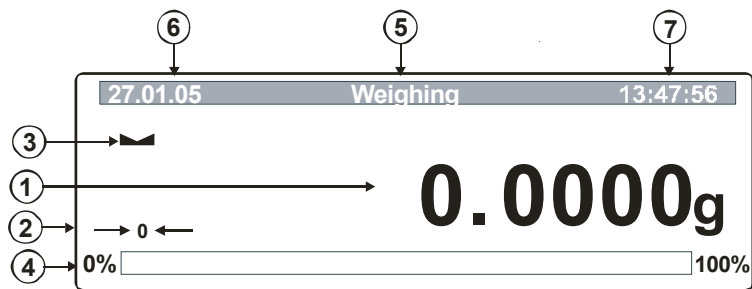

If the display shows the stability display [] the balance is in a stable status. When status is instable the []-display disappears.

Graphic display:



1. Weight display
2. Balance zero-display
3. Stability display
4. Capacity display
5. Mode of operation
6. Current date
7. Current time

• Overview of the keypad:

Key	Function
	<ul style="list-style-type: none"> • Turn on/off • Menu point to the left
	<ul style="list-style-type: none"> • Access to user menu • Menu point to the right
	<ul style="list-style-type: none"> • Option key into operating modes • Decreasing the value for the selected numeral or number • Parameter selection (cursor control downwards)
	<ul style="list-style-type: none"> • Switching between weighing units • Parameter selection (cursor control upwards) • Increasing the value for the selected numeral or number
	<ul style="list-style-type: none"> • Printout of the weighed value on an external appliance (printer or PC) • Confirm/save settings
	<ul style="list-style-type: none"> • Tare • Quit menu • Set weight display at zero

8.1 Operating modes (P8 modes)

In this menu item you can activate/deactivate the following operating modes:

- P8 01: Parts Counting
- P8 02: Check weighing
- P8 03: Filling
- P8 04: Percent weighing
- P8 05: Animal weighing
- P8 06: Density
- P8 07: Formulation
- P8 08: Statistics

Notice: Some operating modes can be combined (e.g. statistics/parts counting, statistics/percent determination). Further details are described in the respective chapters.

Activate/deactivate operating modes:

⇒ In the main menu, call up menu item P8 "Operating mode" (see chapter 7.1)

⇒ Press -key, the overview of the operating modes appears:

20.02.05	Mode	13:47:56
P8 ▶	01 ▶ Parts Count	1 disabled
	02 Checkweighing	0 enabled
	03 Filling	1 disabled
	04 Percent	1 disabled
	05 Animal	0 enabled
	06 Density	1 disabled
	07 Formulation	0 enabled
	08 Statistics	

⇒ Use the arrow keys (see chapter 7.1) to activate (1) or deactivate (0) the desired operating modes.

⇒ Confirm your setting with the -key.

⇒ Save (see chapter 7.1)

All activated operating modes are now stored in a submenu (M0 – M8) and can be called up directly via the -key:





20.02.05	Mode	13:47:56
M0 ▶	Basic weighing	
M1	Parts counting	
M2	Checkweighing	
M3	Filling	
M4	Percent	
M5	Animal weighing	
M6	Density	
M7	Formulation	
M8	Statistics	

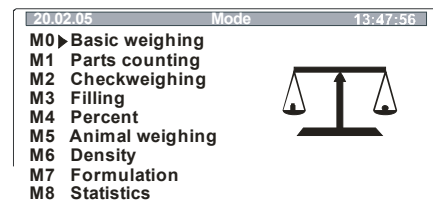

Moving in the operating mode:

- ⇒ Press the  -key
- ⇒ Use the cursor (▶) to select your operating mode



- ⇒ Press the  -key; the parameter selection appears
- ⇒ Use the cursor (▶) to select parameter
- ⇒ Press the  -key; the current menu item blinks
- ⇒ Use the arrow keys (see chapter 7.1) to save your settings. All settings possible are described in the chapters of the respective operating mode
- ⇒ Confirm your setting with the  -key
- ⇒ Press  -key again, the graphic display of the respective operating mode appears. You are now in the operating mode.

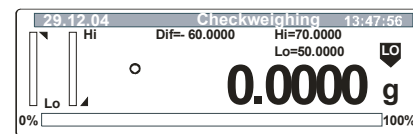

Return to weighing mode:



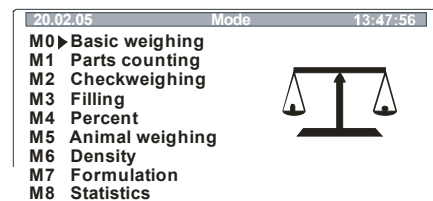

- ⇒ Press  -key
- ⇒ Cursor (▶) to **M0 Basic weighing**



- ⇒ Press the  or the  -key





8.1.1 Simple weighing

Operation:	Display:
⇒ Use the  -key to turn on the balance. or ⇒ Use the  -key to call up menu item "M0 Basic weighing" (chapter 8.1)	
⇒ As soon as the weight display shows „ 0.000 “ your balance is ready for weighing	0,0000
⇒ Put on items to be weighed; after stability time the measuring value is displayed.	19.6879 g
⇒ Pressing the  -key you can switch to another weighing unit, e.g. ct (see Chapter 7.4.6 "P7 Weighing units")	98.4380 ct
⇒ To turn off the balance press the  -key	

8.1.1.1 Tare

The dead weight of any type of weighing container can be tared out by pressing a button, so that subsequent weighing procedures show the net weight of the items to be weighed.

Operation:	Display:
⇒ Use the  -key to turn on the balance.	
⇒ As soon as the weight display shows „ 0.0000 “ your balance is ready for weighing	0.0000 g
⇒ Place items to be weighed on balance, the weighed value is displayed.	19.6879 g
⇒ Press the  -key to start the taring process. The weight of the container is now saved internally.	0.0000 g
⇒ Place the item to be weighed into the tare container. Now read the weight of the items to be weighed on the display.	53.2587 g

The taring process can be repeated any number of times, e.g. for several components for a mixture (add-on weighing).

The limit is reached when the whole weighing range is exhausted.

After removing the tare container the overall weight is displayed in the negative.

8.1.1.2 Under floor weighing

Using under floor weighing allows weighing of objects that because of their size or shape cannot be placed on the pan scale.

Proceed as follows:

- Turn off balance.
- Open the closing lid at the bottom of the balance.
- **Carefully and completely** hook in the hook for under floor weighing.
- Place balance over an opening.
- Suspend the item to be weighed from the hook and carry out weighing.

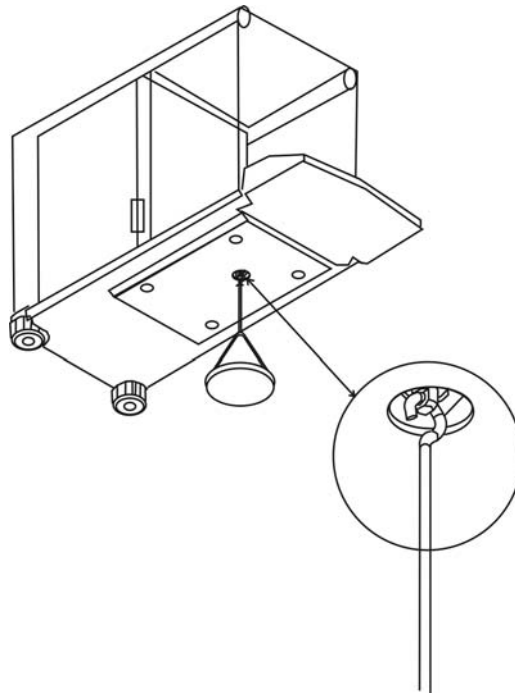

Fig. 1: Setting up balance for under floor weighing



CAUTION

- **Ensure that all suspended objects are stable enough to hold the desired items to be weighed securely (danger of breaking).**
- **Never suspend loads that exceed the stated maximum load (Max) (danger of breaking)**

Always ensure that underneath the load there are no living beings or objects that might be damaged.



NOTE

When the under floor weighing the opening in the bottom of the balance must be closed (protection against dust).

8.1.2 Parts counting

Before the balance can count parts, it must know the average part weight (i.e. reference). This is either entered manually or determined by weighing. Proceed by putting on a certain number of the parts to be counted. The balance determines the total weight and divides it by the number of parts (the so-called reference quantity). Counting is then carried out on the basis of the calculated average piece weight.

As a rule:

The higher the reference quantity the higher the counting accuracy.

Display overview for parts counting operation:

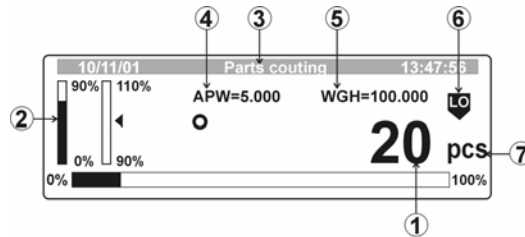









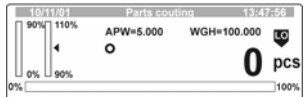

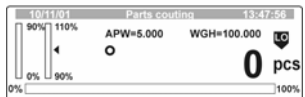

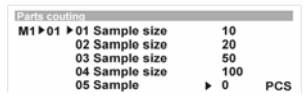
1. Number of all parts on the weighing plate
2. Weighing-in aid coarse/fine (only displayed for active dispensing)
3. Operating mode (status bar)
4. Reference weight
5. Weight of all parts on the weighing plate
6. Tolerance marker (only displayed for active tolerance weighing)

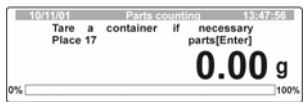
LO	too light
OK	rated value
HI	too heavy

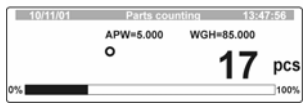
7. Display for parts counting operation

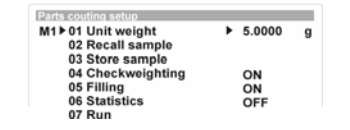
Operator	Indication
<p>⇒ Call up operating mode “M1 Parts counting“ (see chapter 8.1)</p> <p>⇒ Press -key</p>	
<p>⇒ Use the cursor (▶) to select your setting (01 – 07)</p>	
<h3>01 Unit weight – manual input of reference weight</h3>	
<p>⇒ Press the -key; the current menu item blinks. Use the arrow keys (see chapter 7.1) to enter the reference weight for a unit. Confirm with -key</p>	

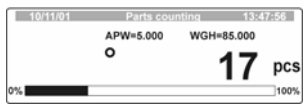
<p>⇒ Press -key; the display changes into parts counting operation</p>	
<p>⇒ The balance is now in parts counting mode counting all units on the weighing plate</p>	
<p>01 Unit weight – determination of reference weight by weighing</p>	
<p>⇒ Press the -key; display changes to parts counting operation</p>	 
<p>⇒ Press the -key; select reference quantity (factory-defined are quantities of 10, 20, 50, 100, or freely selectable), use the  key to confirm</p>	
<p>⇒ Place as many parts on the weighing plate as required by the set reference quantity, confirm by pressing the -key. If you are using a weighing container first tare your balance pressing the -key.</p>	
<p>⇒ Press -key The  symbol in the display indicates that the automatic reference optimization is turned on. Every time more pieces are added the balance carries out optimization automatically. It is not necessary to press another key to start the optimization process. For each reference optimization the average piece weight (reference) is newly calculated. Since additional parts increase the basis for the calculation the reference becomes more exact.</p>	
<p>⇒ Actuate the -key. The reference quantity is saved under “01 Unit weight“.</p>	
<p>⇒ Press the -key; the balance is now in parts counting mode counting all units on the weighing plate.</p>	

02 Recall sample – call up a reference weight from the database

⇒ Use the cursor (▶) to select “02 Recall sample”

Parts counting setup		
M1 ▶ 01 Unit weight	▶ 5.0000	g
02 Recall sample		
03 Store sample		
04 Checkweighting	ON	
05 Filling	ON	
06 Statistics	OFF	
07 Run		

Parts counting setup		
M1 ▶ 01 Unit weight	▶ 5.0000	g
02 Recall sample		
03 Store sample		
04 Checkweighting	ON	
05 Filling	ON	
06 Statistics	OFF	
07 Run		

⇒ Press the -key; the sub-menu “02 Recall sample” will be displayed.

Parts counting setup		
M1 ▶ 02 ▶ 01	BBBB 01	1.5000 g
02	BBBB 02	0.4520 g
03	CCCC 03	1.0032 g
49	AAAA 49	0.0015 g
50	AAAA 50	2.0300 g

⇒ Use the arrow keys to select the desired reference weight

⇒ Use the -key to confirm; the selected reference weight appears under “01 Unit weight”.

Parts counting setup		
M1 ▶ 01 Unit weight	▶ 1.0032	g
02 Recall sample		
03 Store sample		
04 Checkweighting	ON	
05 Filling	ON	
06 Statistics	OFF	
07 Run		

⇒ Press the -key; the balance is now in parts counting mode counting all units on the weighing plate.

Parts counting		13:47:56
APW=5.000	WGH=85.000	
		17 pcs
0%		100%

03 Store sample – Saving a reference weight in the database

The reference weight stored in menu item “01 Unit weight” can be saved in the database as follows (max. 200 Parameter):



⇒ Use the cursor (▶) to select “03 Store sample”

Parts counting setup		
M1 ▶ 01 Unit weight	▶ 5.0000	g
02 Recall sample		
03 Store sample		
04 Checkweighting	ON	
05 Filling	ON	
06 Statistics	OFF	
07 Run		











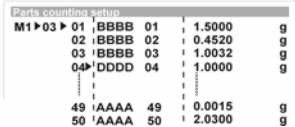

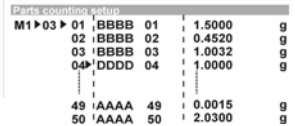
Parts counting setup		
M1 ▶ 01 Unit weight	▶ 5.0000	g
02 Recall sample		
03 Store sample		
04 Checkweighting	ON	
05 Filling	ON	
06 Statistics	OFF	
07 Run		

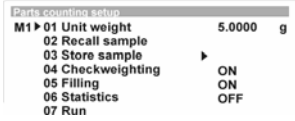
⇒ Press the -key; the sub-menu “03 Store sample” will be displayed.

Parts counting setup		
M1 ▶ 02 ▶ 01	BBBB 01	1.5000 g
02	BBBB 02	0.4520 g
03	CCCC 03	1.0032 g
49	AAAA 49	0.0015 g
50	AAAA 50	2.0300 g

⇒ Use the arrow keys ( or ) to select parameter no.

Parts counting setup		
M1 ▶ 03 ▶ 01	BBBB 01	1.5000 g
02	BBBB 02	0.4520 g
03	BBBB 03	1.0032 g
04 ▶	stable 04	1.0000 g
49	AAAA 49	0.0015 g
50	AAAA 50	2.0300 g

<p>⇒ Press the -key; use the arrow keys to enter parameter name (max. 10 characters)</p>	
<p>⇒ Use the -key to confirm, the blinking stops</p>	
<p>⇒ Press the -key; return to menu</p>	
<h3>04 Checkweighing</h3> <p>The combination parts counting / checkweighing allows you to check whether your reference weight is within your set tolerance</p>	
<p>⇒ Use the cursor (▶) to select the “04 Checkweighing”</p> <p>⇒ Press -key</p>	
<p>⇒ Press the -key; the current menu item blinks.</p> <p>⇒ Activate operating mode “Checkweighing” via the arrow keys</p> <p>⇒ Set tolerance limits</p>	
<p>⇒ Confirm with -key</p>	
<p>⇒ Press the -key; return to menu</p>	

05 Filling

The combination of parts counting /filling allows your to set a target quantity.

⇒ Use the cursor (▶) to select the **“05 Filling”**

⇒ Press  -key



⇒ Press the  -key; the current menu item blinks.

⇒ Activate operating mode “Filling” via arrow keys

⇒ Enter value for the target quantity



⇒ Confirm with  -key

⇒ Press the  -key; return to menu

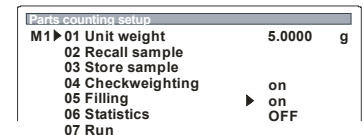

06 Statistics

When combining parts counting /statistics the displayed value is accepted by pressing the  -key.

⇒ Use the cursor (▶) to select **“06 Statistics”**

⇒ Press  -key



⇒ Press the  -key; the current menu item blinks



⇒ Use the cursor (▶) to select **“03 Clear”**

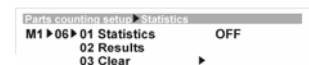

⇒ Press the  -key; data will be deleted



⇒ Confirm with  -key













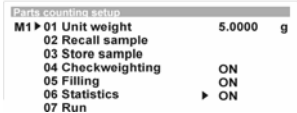

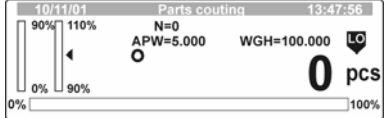
⇒ Use the cursor (▶) to select **01 Statistics**

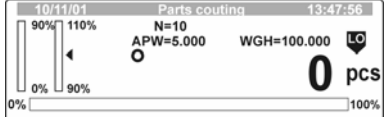
⇒ Press  -key

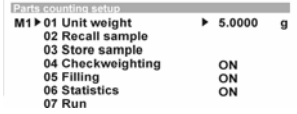
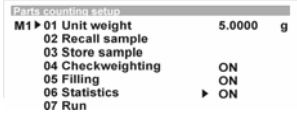

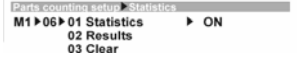
⇒ Activate operating mode “Statistics” with the arrow keys; press the  -key to confirm



<p>⇒ Press the -key; return to menu</p>	 <pre> Parts counting setup M1 ▶ 01 Unit weight 5.0000 g 02 Recall sample 03 Store sample 04 Checkweighting ON 05 Filling ON 06 Statistics ▶ ON 07 Run </pre>
<p>⇒ Press the -key; the balance is now in parts counting mode</p>	 <pre> 10/11/01 Parts counting 13:47:56 90% 110% N=0 APW=5.000 WGH=100.000 0 pcs 0% 100% </pre>
<p>⇒ After each measuring (stable measuring value) press the -key; the displayed value will be saved and added to the saved number of values (N).</p>	 <pre> 10/11/01 Parts counting 13:47:56 90% 110% N=10 APW=5.000 WGH=100.000 0 pcs 0% 100% </pre>
<p>⇒ Calling up the statistic results after e.g. 10 measurements (N=10) Use the -key to call up the sub- menus</p>	 <pre> Parts counting setup M1 ▶ 01 Unit weight 5.0000 g 02 Recall sample 03 Store sample 04 Checkweighting ON 05 Filling ON 06 Statistics ▶ ON 07 Run </pre>
<p>⇒ Use the cursor (▶) to select “06 Statistics”</p>	 <pre> Parts counting setup M1 ▶ 01 Unit weight 5.0000 g 02 Recall sample 03 Store sample 04 Checkweighting ON 05 Filling ON 06 Statistics ▶ ON 07 Run </pre>
<p>⇒ Confirm with -key</p>	 <pre> Parts counting setup ▶ Statistics M1 ▶ 06 ▶ 01 Statistics ▶ ON 02 Results 03 Clear </pre>
<p>⇒ Use the cursor (▶) to select “02 Results”</p>	 <pre> Parts counting setup ▶ Statistics M1 ▶ 06 ▶ 01 Statistics ON 02 Results ▶ 03 Clear </pre>
<p>⇒ Use the -key to confirm; the display will show your statistical results.</p>	 <pre> Parts counting setup ▶ Statistics N=10 SUM=40 X=4 MIN=4 MAX=5 D=1 SDV=2 RDV=52.7 </pre>

⇒ By actuating the -key you can print your statistical results on a connected printer (see example).

N : 10	→	Number of weighing proc.
SUM: 40 pcs	→	Total of all weight values
X : 4 pcs	→	Average Value
MIN : 4 pcs	→	Smallest value
MAX: 5 pcs	→	Largest value
D : 1 pcs	→	MAX – MIN
SDV : 2 pcs	→	Standard Deviation
RDV : 52,7 %	→	Variance

⇒ Press -key

```
Parts counting setup ▶ Statistics
M1 ▶ 06 ▶ 01 Statistics ON
02 Results ▶
03 Clear
```

⇒ Use the -key to return to the sub-menu



```
Parts counting setup
M1 ▶ 01 Unit weight 5.0000 g
02 Recall sample
03 Store sample
04 Checkweighting ON
05 Filling ON
06 Statistics ▶ ON
07 Run
```

06 Run

Parameter selection “**M1 07 RUN**” (confirm with -key) will take you directly into parts counting mode.

8.1.2.1 Printout data output

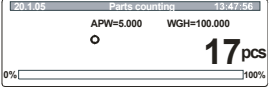
Standard data output:

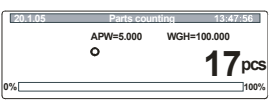
Key	Indication	GLP Parameters	Data output
		<p>P2 03 time printout 0: no P2 04 date printout 0: no P2 05 user printout. 0: no P2 06 project printout 0: no P2 07 printout Id 0: no P2 08 cal printout. 0: no</p>	17 pcs
		<p>P2 03 time printout 1: yes P2 04 date printout 1: yes P2 05 user printout. 1: yes P2 06 project printout 1: yes P2 07 printout Id 1: yes P2 08 cal printout. 1: yes</p>	<p>Date: 16/01/2004 Time 13:12:30 User: Mustermann Project: Checking. Weight: 11111111 Last adjustment: ----- 16/01/2004 13:02 External adjustment: 0.0001 g ----- 17 pcs</p>

User-defined data output

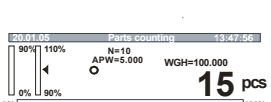
Key	Indication	Variable selection	Data output
		<p>%d; %t; %i; %R; %P; %U; %F; %V; %N; %W; %n; %x; %S; %m; %M; %D; %s; %r; %C; %K; %l;</p>	<p>17/01/2004 08:16:09 11111111 MBA 0.01 Checking. Mustermann. quantity 15 pcs 15.048 g 5.30000 g 13 15 pcs 195 pcs 15 pcs 17 pcs 2 pcs 0 pcs 0.00 % 16/01/2004 13:02 External adjustment: 0.01 g</p>

8.1.3 Checkweighing (Weighing with tolerance range)

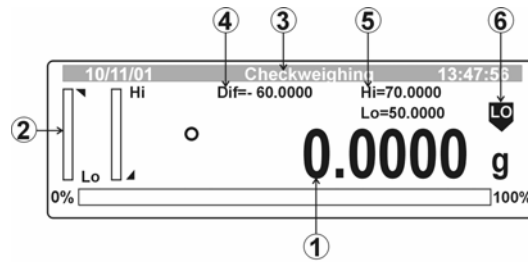

Overview of display:



1. Current weight display
2. Weighing-in aid coarse/fine
3. Mode of operation
4. Rated value
5. Upper limit (Hi), lower limit (Lo)
6. Tolerance marker

LO	too light
OK	rated value
HI	too heavy

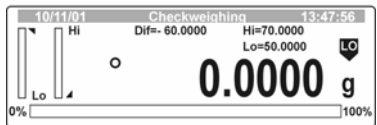
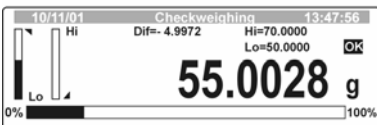
Operator	indication
<p>⇒ Call up operating mode “M2 Checkweighing “ (see chapter 8.1)</p> <p>⇒ Press -key</p>	
<p>01 - 02 low/high limit – Enter limiting values</p>	
<p>⇒ Use the cursor (▶) to select “01 Lower limit or 02 upper limit“</p>	
<p>⇒ Press the -key; the current menu item blinks. Use the arrow keys (see chapter 7.1) to enter limiting values and confirm with the -key. Remark: At first set parameter 02 high limit.</p>	
<p>⇒ Use the cursor (▶) to select 04 Run and confirm with the -key</p>	

<p>⇒ The balance is now in “Weighing with tolerance range“ mode</p>	 <p>The image shows a balance display with the date 10/11/01, time 13:47:56, and the word 'Checkweighing'. It displays a weight of 0.0000 g. The tolerance range is set with Dif=-60.0000, Hi=70.0000, and Lo=50.0000. A progress bar at the bottom indicates 0% to 100%.</p>
<p>⇒ Put on goods to be weighed, tolerance control is started</p>	 <p>The image shows the same balance display as above, but now with a weight of 55.0028 g. The tolerance range parameters remain the same. The progress bar is partially filled.</p>
<p>03 Statistics- Combination checkweighing/statistics</p>	
<p>⇒ Use the cursor (▶) to select “03 Statistics“,</p>	 <p>The image shows a 'Checkweighing setup' menu with the following options: M2 ▶ 01 Low limits (0.0000 g), 02 High limits (0.0000 g), 03 Statistics (OFF), and 04 Run.</p>
<p>⇒ All further steps are the same as for the combination parts count/statistics (chapter 8.1.2)</p>	

8.1.4 Filling

Display overview for filling operation:

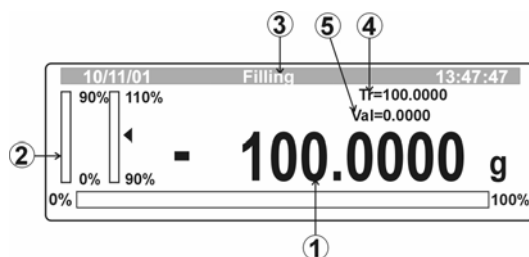

1. Residual filling quantity
2. Weighing-in aid coarse/fine
3. Mode of operation
4. Target weight
5. Present weight of sample

Operator	indication
<p>⇒ Call up operating mode “M3 Filling“ (see chapter 8.1)</p> <p>⇒ Press -key</p>	
<p>⇒ Use the cursor (▶) to select 01 Target weight</p>	
<p>⇒ Press the -key; the current menu item blinks. Use the arrow keys (see chapter 7.1) to enter the target value.</p>	
<p>⇒ Confirm with -key</p>	
<p>⇒ Use the cursor (▶) to select 03 Run and confirm with the -key; the balance is now in Filling mode</p>	
<p>02 Statistics combination Filling/statistics</p>	
<p>⇒ Use the cursor (▶) to select “02 Statistics“</p>	
<p>⇒ All further steps are the same as for the combination parts count/statistics (chapter 8.1.2)</p>	

8.1.5 Percent determination





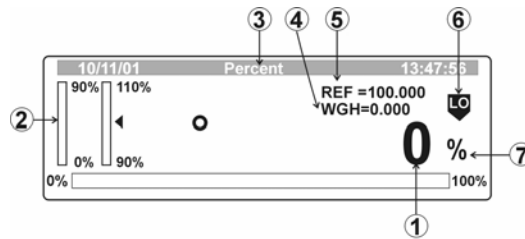

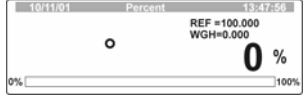

Percent determination allows weight display in percent, in relation to a reference weight

Display overview for percent determination operation:

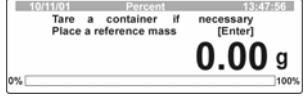

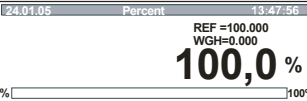
1. % - deviation to reference weight
2. Weighing-in aid coarse/fine (only displayed for active dispensing)
3. Mode of operation
4. Present weight of sample
5. Reference weight
6. Tolerance marker (only displayed for active tolerance weighing)
7. Percent determination mode

Operator	indication
<p>⇒ Call up operating mode “M4 Percent“ (see chapter 8.1)</p> <p>⇒ Press -key</p>	
<p>01 Reference – Numeric entry of the reference weight</p>	
<p>⇒ Use the cursor (▶) to select “01 Reference“</p>	
<p>⇒ Press the -key; the current menu item blinks. Use the arrow keys (see chapter 7.1) to enter reference weight and confirm with the -key.</p>	
<p>⇒ Press the -key; the balance is now in percent determination mode.</p>	
<p>⇒ Now place items to test onto the weighing plate, the percentage in relation to the reference part is displayed.</p>	

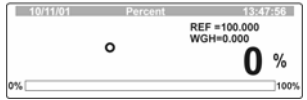



01 Reference – determination of reference weight by weighing	
⇒ Percent determination mode	 
⇒ Press  -key. Put on reference weight; if necessary, tare first	
⇒ Press  -key, the weight is stored as reference (100%).	
⇒ Now place items to test onto the weighing plate, the percentage in relation to the reference part is displayed.	
02 Decimal places	
⇒ Use the cursor (▶) to select “02 Decimal places“,	
⇒ Press the  -key; the current menu item blinks. Use the arrow keys (see chapter 7.1) to enter decimal digits; confirm with the  -key	
⇒ Press the  -key; the balance is now in percent determination mode.	
03 Checkweighing 04 Filling 05 Statistics 06 Run	
⇒ Use the cursor (▶) to select parameter “03 - 06“	
⇒ All further steps are the same as for the combination parts count/statistics (chapter 8.1.2)	





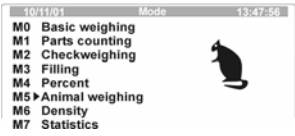



8.1.6 Animal weighing (Dynamic weighing)

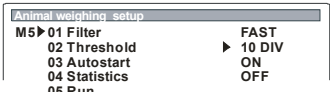

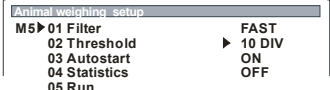

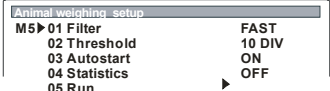

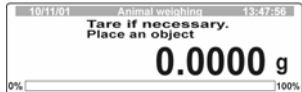
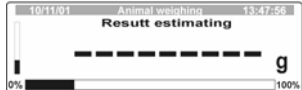
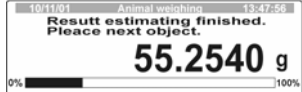



For unsteady items to be weighed (e.g. animals) or strong vibrations you can activate the dynamic weighing function with automatic or manual start. During a certain period of time the balance determines weight values and calculates an average.

In **automatic start** measuring starts automatically as soon as the weight changes.

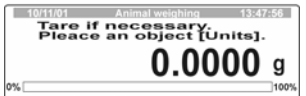
In **manual start** you trigger measuring by actuating the **F**-key.

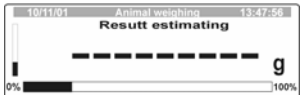
Operator	indication
<p>⇒ Call up operating mode “M5 Animal weighing” (see chapter 8.1)</p> <p>⇒ Press -key</p>	
<p>01 Filter – filter for adjustment to the environmental conditions Vibrations are filtered out by increasing the number of measuring cycles.</p>	
<p>⇒ Use the cursor (▶) to select “01 Filter”</p>	
<p>⇒ Press the -key; the current menu item blinks. Use the arrow keys (see chapter 7.1) to enter the sensitivity of the filter and confirm with the -key.</p> <p style="text-align: center;"> slowest (insensitive, very busy setup location) slow normal fast fastest (sensitive very quiet setup location) </p> <p style="text-align: center;">↓</p>	

<p>02 Threshold (Condition: 03 – Auto start activated)</p>	
<p>⇒ Use the cursor (▶) to select “02 Threshold”</p>	
<p>⇒ Press the -key; the current menu item blinks. Use the arrow keys (see chapter 7.1) to set the number of measurements used for averaging. Confirm by pressing the -key</p> <p style="text-align: center;">10 DIV ↓ 1000 DIV</p>	
<p>03 Weighing with automatic start After selecting your parameters and with 03 Auto start activated, carry out weighing as follows:</p>	
<p>⇒ Use the cursor (▶) to select “05 Run”. Confirm by pressing the -key</p>	
<p>⇒ If you are using a weighing container use the -key for taring</p>	
<p>⇒ Put goods to be weighed on weighing plate</p>	
<p>⇒ Dynamic weighing is started automatically.</p>	
<p>⇒ When weighing is complete the weight is shown in the display</p>	
<p>⇒ To start a new weighing cycle relieve the balance</p>	
<p>⇒ Press the -key; return to menu</p>	

<p>03 Weighing with manual start After selecting your parameters and with 03 Auto start deactivated, carry out weighing as follows:</p>	
<p>⇒ Use the cursor (▶) to select “05 Run“. Confirm by pressing the -key</p>	
<p>⇒ If you are using a weighing container use the -key for taring</p>	
<p>⇒ Put goods to be weighed on weighing plate</p>	
<p>⇒ Dynamic weighing is started by actuating the -key</p>	
<p>⇒ When weighing is complete the weight is shown in the display</p>	
<p>⇒ To start a new weighing cycle relieve the balance and press the -key</p>	
<p>⇒ Press the -key; return to menu</p>	

8.1.7 Density determination

Density determination of solids and liquids see user manual “Density set”.

8.1.8 Formulation



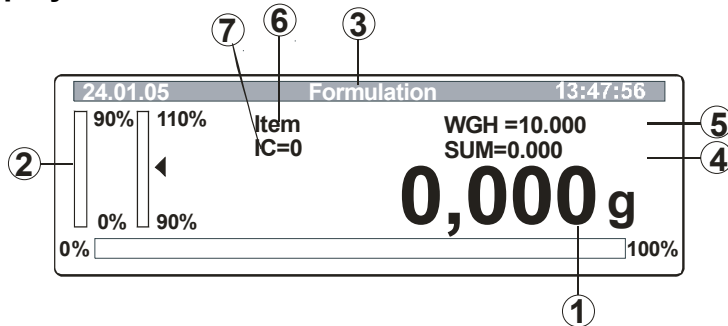

The formulation function allows to add on various components of a mixture. To check, the overall weight of all components can be called up.

Overview of display:



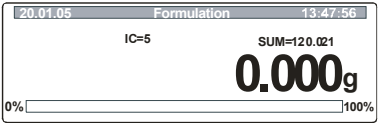

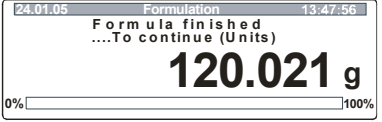
1. Present weight of sample
2. Weighing-in aid coarse/fine
3. Mode of operation
4. Sum memory
5. Target value of a component (defined in parameter 04 Formula)
6. Data of a component (defined in parameter 04 Formula)
7. Number of added components

Operator	indication
<p>⇒ Call up operating mode “M7 Formulation“ (see chapter 8.1)</p> <p>⇒ Press -key</p>	
<h4>01 – 07 Parameter selection</h4>	
<p>⇒ Use the cursor (▶) to select parameter “01 - 07“</p>	

<p>⇒ Add on component 2; as soon as the measuring value is stable actuate the -key</p> <p>⇒ Repeat this step until you have added all components.</p>	
<p>⇒ Confirm adding of the last component with the -key</p> <p>⇒ Confirm completion of the mixture with the -key</p>	
<p>⇒ Press the -key; return to menu</p>	

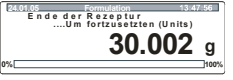
Example for a data output (standard printout)

Key	Indication	GLP Parameters		Data output																																
		<i>P2 03</i> printout of time <i>P2 04</i> printout of date <i>P2 05</i> user's printout <i>P2 06</i> printout of design <i>P2 07</i> printout Id <i>P2 08</i> printout of calibration	<i>0: no</i> <i>0: no</i> <i>0: no</i> <i>0: no</i> <i>0: no</i> <i>0: no</i>	<table border="0"> <tr><td>1</td><td>10.000 g</td></tr> <tr><td>2</td><td>10.000 g</td></tr> <tr><td>3</td><td>10.002 g</td></tr> <tr><td colspan="2">-----</td></tr> <tr><td>SUM</td><td>30.002 g</td></tr> </table>	1	10.000 g	2	10.000 g	3	10.002 g	-----		SUM	30.002 g																						
1	10.000 g																																			
2	10.000 g																																			
3	10.002 g																																			

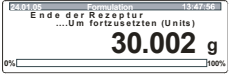
SUM	30.002 g																																			
		<i>P2 03</i> printout of time <i>P2 04</i> printout of date <i>P2 05</i> user's printout <i>P2 06</i> printout of design <i>P2 07</i> printout Id <i>P2 08</i> printout of calibration	<i>1: yes</i> <i>1: yes</i> <i>1: yes</i> <i>1: yes</i> <i>1: yes</i> <i>1: yes</i>	<table border="0"> <tr><td>Date:</td><td>16/01/2004</td></tr> <tr><td>Time</td><td>13:12:30</td></tr> <tr><td>User:</td><td>Mustermann</td></tr> <tr><td>Project:</td><td>xxxxx</td></tr> <tr><td>Balance:</td><td>:11111111</td></tr> <tr><td>Last adjustment:</td><td></td></tr> <tr><td colspan="2">-----</td></tr> <tr><td></td><td>16/01/2004 13:02</td></tr> <tr><td>External adjustment</td><td></td></tr> <tr><td>Deviation:</td><td>0.0001 g</td></tr> <tr><td colspan="2">-----</td></tr> <tr><td>1</td><td>10.000 g</td></tr> <tr><td>2</td><td>10.000 g</td></tr> <tr><td>3</td><td>10.002 g</td></tr> <tr><td colspan="2">-----</td></tr> <tr><td>SUM</td><td>30.002 g</td></tr> </table>	Date:	16/01/2004	Time	13:12:30	User:	Mustermann	Project:	xxxxx	Balance:	:11111111	Last adjustment:		-----			16/01/2004 13:02	External adjustment		Deviation:	0.0001 g	-----		1	10.000 g	2	10.000 g	3	10.002 g	-----		SUM	30.002 g
Date:	16/01/2004																																			
Time	13:12:30																																			
User:	Mustermann																																			
Project:	xxxxx																																			
Balance:	:11111111																																			
Last adjustment:																																				

	16/01/2004 13:02																																			
External adjustment																																				
Deviation:	0.0001 g																																			

1	10.000 g																																			
2	10.000 g																																			
3	10.002 g																																			

SUM	30.002 g																																			

8.1.9 Statistics

The Statistical function is possible for display values in g, pieces or %.

By actuating the -key the currently displayed value is saved for the statistics.

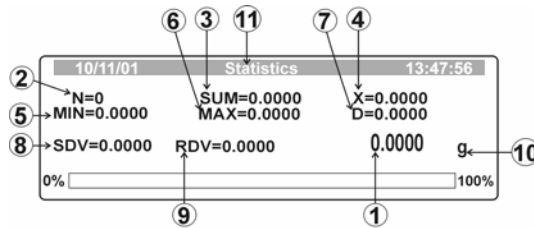

Overview of display:





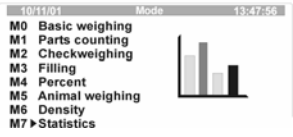
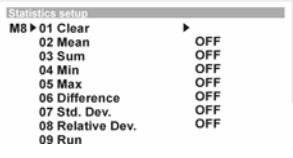

1. Present weight of sample
2. Number of all weight proc.
3. Total of all weight values
4. Average value
5. Smallest value
6. Largest value
7. Difference Max-Min



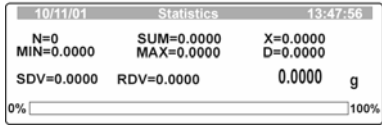

$$\sqrt{\frac{n \sum x^2 - (\sum x)^2}{n(n-1)}}$$

8. Standard deviation SDV:
9. Variance RDV: (SDV / average) * 100%
10. Weighing unit
11. Mode of operation

Operator	indication
<p>⇒ Call up operating mode “M8 Statistics“ (see chapter 8.1)</p> <p>⇒ Press -key</p>	
01 – 08 Parameter selection	
<p>⇒ Use the cursor (▶) to select parameter “01 - 08“</p>	
<p>⇒ Press the -key; the current menu item blinks.</p> <p>01 Clear Delete data</p> <p>02 Sum Sum of all Weighings</p> <p>03 Mean Rated value</p> <p>04 Min Minimum</p> <p>05 Max Maximum</p> <p>06 Difference Difference min/max</p> <p>07 Stand. Devi. Standard Deviation</p> <p>08 Factor variance Variance</p> <p>09 Run Enter statistics mode</p>	

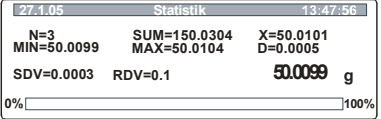
⇒ Use the arrow keys to activate/deactivate parameters, confirm your selection pressing the  key	
⇒ Press the  -key; the balance is now in statistics mode.	
⇒ Use the  -key to print your statistic values on a connected printer	Prinout: <div style="border: 1px solid black; padding: 5px; margin-top: 10px;"> <pre> N : 5 SUM : 169,6880 g X : 33,9376 g Min : 0,0000 g MAX : 100,0012 g D : 100,0012 g SDV : 42,2166 g RDV : 124,4% </pre> </div>
Press the  -key; return to menu	

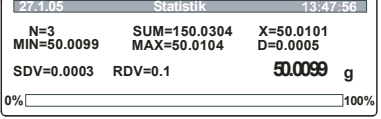
Example for a data output during a measuring sequence:

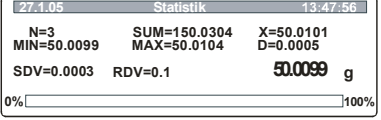
Key	Indication	GLP Parameters	Data output
		<i>P2 03 time printout 0: no</i> <i>P2 04 date printout 0: no</i> <i>P2 05 user printout. 0: no</i> <i>P2 06 project printout. 0: no</i> <i>P2 07 printout Id 0: no</i> <i>P2 08 Cal printout. 0: no</i>	3 50.0099 g
		<i>P2 03 time printout 1: yes</i> <i>P2 04 date printout 1: yes</i> <i>P2 05 user printout. 1: yes</i> <i>P2 06 project printout 1: yes</i> <i>P2 07 printout Id 1: yes</i> <i>P2 08 Cal printout. 1: yes</i>	Date: 16/01/2004 Time 13:12:30 User: Mustermann Project: xxxxx Weight: : 11111111 Last adjustment: ----- 16/01/2004 13:02 External adjustment: 0.0001g ----- 3 50.0099 g
			N : 3 SUM : 150.0304 g X : 50.0101 g Min : 50.0099 g MAX : 50.0104 g D : 0.0005 g SDV : 0.0003 g RDV : 0.01 %

9 Data output

9.1 Technical data

- 8 Data bits
- Baud rate selectable at 2400, 4800, 9600 and 19200 Baud
- Miniature plug necessary (9 pol D-Sub)
- For operation with interface faultless operation is ensured only with the respective KERN- interface cable (max. 2m)

9.2 Pin allocation of the balance exit plug (front view)

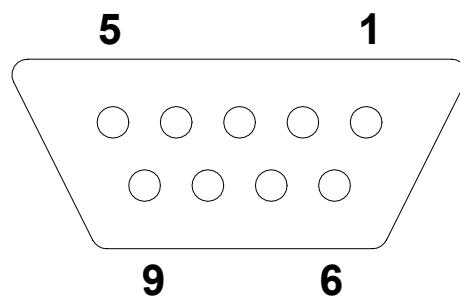

Pin 2:	Rxd
Pin 3:	Txd
Pin 4:	DTR
Pin 5:	GND
Pin 6:	Tara
Pin 7:	RTS
Pin 8:	CTS
Pin 9:	Print

9.3 Remote commands

Commands	function
R CR LF	Reset to factory setting – reset
PC CR LF	Command to call up the values of the balance
S CR LF	Measuring value stable
SI CR LF	Measuring value instable
SU CR LF	Last stable measuring value
SUI CR LF	Current measuring value
Z CR LF	Zeroing stable value
ZI CR LF	Zeroing instable value
T CR LF	Taring stable value
TI CR LF	Taring instable value
C0 CR LF	Cancel continuous data output
C1 CR LF	Start continuous data output
CU0 CR LF	Cancel continuous data output (operating mode)
CU1 CR LF	Start continuous data output (operating mode)
NB CR LF	Serial no. of balance
FS CR LF	Weighing range max.
RV CR LF	Software issue
PD CR LF	Date display
PD CR LF	Time display
PMCR LF	Mode of operation
PS CR LF	Balance parameters are printed out
B CR LF	Keystone
ER CR LF	Call up error message
DS CR LF	Display check
CS CR LF	Delete display check
DH CR LF	Display check header
CH CR LF	Delete display check header
DF CR LF	Display check bar graph (footer)
CF CR LF	Delete display check bar graph (footer)
CL CR LF	Start internal adjustment from outside
KL CR LF	Lock keyboard
KU CR LF	Unlock keyboard
E0 CR LF	Keystone off
E1 CR LF	Keystone on
O0 CR LF	Balance off
O1 CR LF	Balance on
A0 CR LF	Auto zero off
A1 CR LF	Auto zero on
TC0 CR LF	Automatic adjustment off
TC1 CR LF	Automatic adjustment on

10 Maintenance, upkeep, disposal

10.1 Cleaning

Please disconnect the device from the operating voltage before cleaning.

Only use a cloth dampened with mild suds and not aggressive cleaning agents (solvents or similar). Please ensure that fluids are not able to get into the device and rub off using a clean, soft cloth.

Loose sample residue/powder can be removed carefully using a brush or hand vacuum cleaner.

Remove any spilt material to be weighed immediately.

10.2 Maintenance, upkeep

The device may only be opened by trained service engineers authorised by KERN. Disconnect from the mains supply before opening.

10.3 Disposal

The operating company shall dispose of the packaging and the device in compliance with the valid national or regional law of the operating location.

11 Troubleshooting

The balance should be switched off for a short time following an interruption in the programme sequence and disconnected from the mains supply. It is then necessary to repeat the weighing process from the beginning.

Help:

Malfunction

Possible cause

Weight display is not illuminated.

- *The balance is not switched on.*
- *The mains supply connection has been interrupted (mains cable not plugged in/faulty).*
- *Power supply interrupted.*
- *Batteries are inserted incorrectly or empty*
- *There are no batteries inserted.*

The weight display changes continually

- *Draught/air movement*
- *Table/floor vibrations*
- *Weighing plate has contact with other objects.*
- *Electromagnetic fields / static charging (choose different location/switch off interfering device if possible)*

The weighing result is obviously wrong

- *The display of the balance is not at zero*
- *Adjustment is no longer correct.*
- *Great fluctuations in temperature.*
- *Electromagnetic fields / static charging (choose different location/switch off interfering device if possible)*

Switch the balance off if other error messages should appear and then switch on again. If error message persists, inform manufacturer.